

Power meter

# M1M 20

## User manual

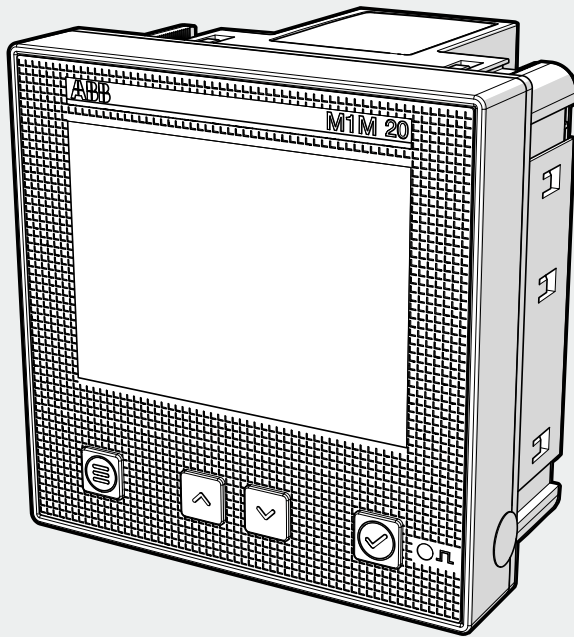



# Table of Contents

<b>1.General information.....</b>	<b>5</b>
1.1.Use and storage of the manual.....	5
1.2.Copyright .....	5
1.3.Liability disclaimer .....	5
1.4.General safety warnings .....	5
1.5.Cyber Security Disclaimer.....	6
<b>2.Packaging contents.....</b>	<b>7</b>
<b>3.Technical characteristics .....</b>	<b>8</b>
3.1.Description of the device .....	8
3.2.Main functionalities.....	8
3.3.Versions.....	8
3.4.Overall dimensions .....	9
3.5.Technical data.....	10
<b>4.Installation .....</b>	<b>12</b>
4.1.Assembly.....	12
4.2.Disassembly.....	13
4.3.Wiring diagrams.....	14
<b>5.Access to device .....</b>	<b>18</b>
5.1.Display .....	18
5.2.Buttons .....	20
5.3.Data entry.....	21
<b>6.First commissioning.....</b>	<b>24</b>
6.1.Password for the first use (PASS) .....	24
6.2.Wiring (WIRI) .....	25
6.3.CT ratio (CT).....	25
6.4.VT ratio (VT).....	26
<b>7.Configuration (CONF).....</b>	<b>27</b>
7.1.Unit (UNIT) .....	28
7.2.Installation (INSTL) .....	31
7.3.Input / output (I/O) .....	31
7.4.Alarms (ALM) .....	34
7.5.Communication (COMM) .....	40
<b>8.Data reading (READ) .....</b>	<b>43</b>
8.1.Realtime (REAL) .....	43

8.2.Energy (ENRG) ..... 45  
8.3.Power Quality (PWQT)..... 46  
8.4.I/O .....47  
8.5.Notifications (NOTF)..... 48  
8.6.Timers (TIME) ..... 50

---

# 1. General information

---

## 1.1. Use and storage of the manual



Carefully read this manual and adhere to the indications described prior to using the device.

This manual contains all of the safety information, the technical aspects and the operations necessary to ensure the correct use of the device and maintain it in safe conditions.

---

## 1.2. Copyright

The copyright of this manual is the property of **ABB LV Installation Materials Co. Ltd. Beijing**. This manual contains texts, designs and illustrations of a technical nature which must not be disclosed or transmitted to third parties, even partially, without the written authorisation of **ABB LV Installation Materials Co. Ltd. Beijing**.

---

## 1.3. Liability disclaimer

The information contained in this document is subject to change without notice and cannot be considered as an obligation by **ABB LV Installation Materials Co. Ltd. Beijing**. **ABB LV Installation Materials Co. Ltd. Beijing** is not liable for any errors that may appear in this document. **ABB LV Installation Materials Co. Ltd. Beijing** is not liable under any circumstances for any direct, indirect, special, incidental or consequential damage of any kind that may arise from using this document. **ABB LV Installation Materials Co. Ltd. Beijing** is also not liable for incidental or consequential damage that may arise from using the software or hardware mentioned in this document.

---

## 1.4. General safety warnings



Non-adherence to the following points can lead to serious injury or death.

Use the suitable personal protection devices and adhere to the current regulations governing electrical safety.

- This device must be installed exclusively by qualified personnel who have read all of the information relative to the installation.
- Check that the voltage supply and measurement are compatible with the range permitted by the device.
- Ensure that all current and voltage supplies are disconnected prior to carrying out any controls, visual inspections and tests on the device.
- Always assume that all circuits are under voltage until they are completely disconnected, subjected to tests and labelled.
- Disconnect all of the power supply prior to working on the device.
- Always use a suitable voltage detection device to check that the supply is interrupted.
- Pay attention to any dangers and carefully check the work area ensuring that no instruments or foreign objects have been left inside the compartment in which the device is housed.
- The correct use of this device depends on a correct manipulation, installation and use.
- Failure to adhere to the basic installation information can lead to injuries as well as damage to the electric instruments or to any other product.
- **NEVER** connect an external fuse in by-pass.
- Disconnect all of the input and output wires before carrying out a dielectric rigidity test or an insulation test on an instrument in which the device is installed.
- The tests carried out at a high voltage can damage the device's electronic components.
- The device has to be installed inside a switchboard.
- Installation of M1M shall include a switch or circuit breaker for the connection of auxiliary supply and voltage measurement. The switch or circuit breaker must be suitably located and easily reachable and must be marked as the disconnecting device for M1M.
- Switch off circuit breaker or switch before disconnecting from the auxiliary supply and voltage measurement or connecting to the auxiliary supply or voltage measurement.

---

## 1.5.Cyber Security Disclaimer

M1M 20 power meter is designed to be connected and to communicate information and data via a network interface, which should be connected to a secure network. It is your sole responsibility to provide and continuously ensure a secure connection between the product and your network or any other network (as the case may be) and to establish and maintain appropriate measures (such as but not limited to the installation of firewalls, application of authentication measures, encryption of data, installation of antivirus programs, etc.) to protect the M1M 20 power meter product, the network, its system and interfaces against any kind of security breaches, unauthorized access, interference, intrusion, leakage and/or theft of data or information. **ABB LV Installation Materials Co. Ltd. Beijing** and its affiliates are not liable for damages and/ or losses related to such security breaches, unauthorized access, interference, intrusion, leakage and/or theft of data or information.

Although **ABB LV Installation Materials Co. Ltd. Beijing** provides functionality testing on the products and updates that we release, you should institute your own testing program for any product updates or other major system updates (to include but not limited to code changes, configuration file changes, third party software updates or patches, hardware change out, etc.) to ensure that the security measures that you have implemented have not been compromised and system functionality in your environment is as expected.

## 2. Packaging contents

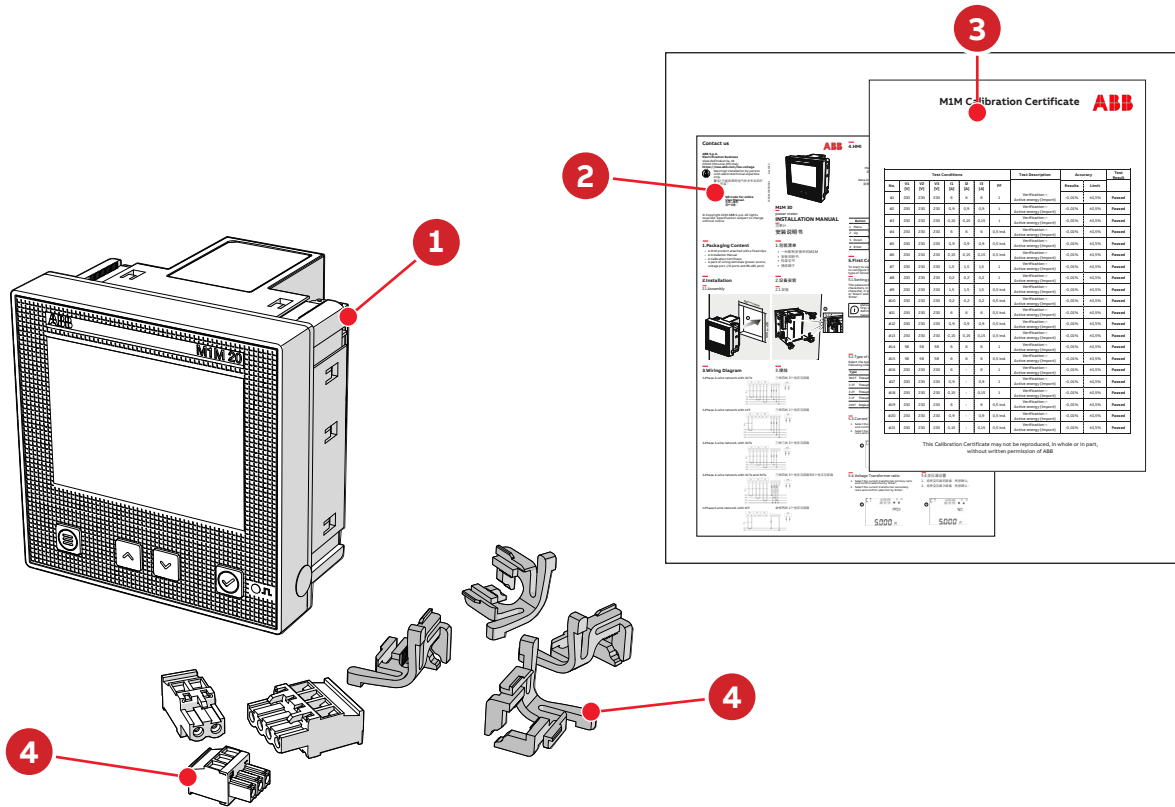

### Packaging contents

1	Power meter M1M 20
2	Installation manual
3	Calibration certificate
4	Installation accessories (removable terminals, fixing clips)



The number and type of removable terminals in the package varies according to the different versions.

## 3. Technical characteristics

### 3.1. Description of the device

M1M series can help users accurately monitor energy efficiency while meeting their cost control requirement.

Conforming to the international electric energy metering and monitoring accuracy standards, all M1M series products are perfectly suitable for ABB electrical systems and solutions.

### 3.2. Main functionalities

<b>Real-time Measurement</b>	
TRMS Current	•
TRMS Voltage	•
Frequency	•
Active, Reactive and Apparent Power	•
Power Factor	•
Operating timer, countdown timer	•
<b>Energy</b>	
Active, Reactive and Apparent Energy	•
Four-quadrant (Import/Export)	•
<b>Power quality</b>	
THD (I, V)	•
Neutral current	Calculated
<b>Data recording and logs</b>	
Alarms	15
Warnings, alarms and errors logs	•

### 3.3. Versions

<b>Product Name</b>	<b>I/O</b>	<b>Communication protocol</b>
M1M 20 I/O	2 digital inputs, 2 digital outputs	Modbus RTU
M1M 20 MODBUS	-	Modbus RTU
M1M 20 ETHERNET	-	Modbus TCP/IP
M1M 20	-	-



### 3.4. Overall dimensions

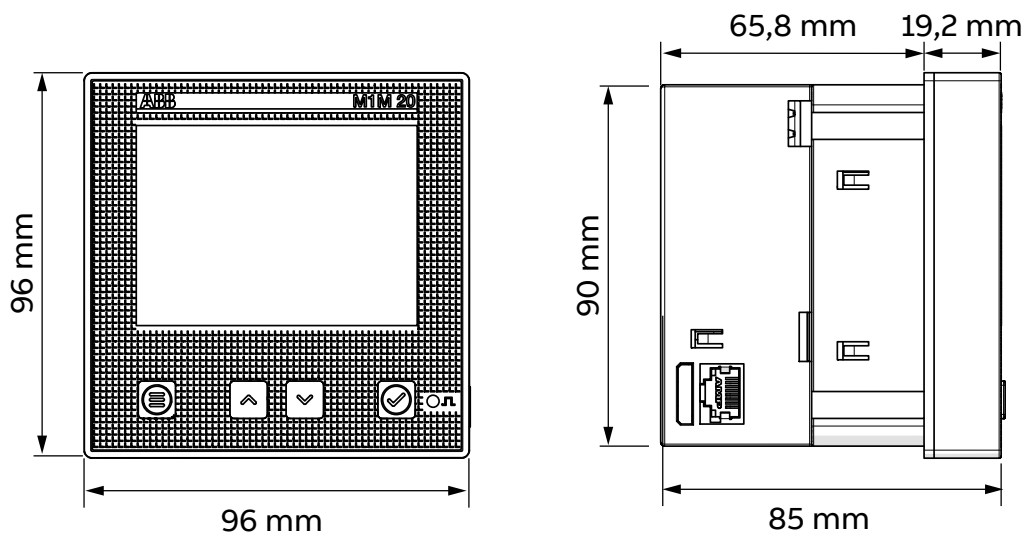

IEC 61554

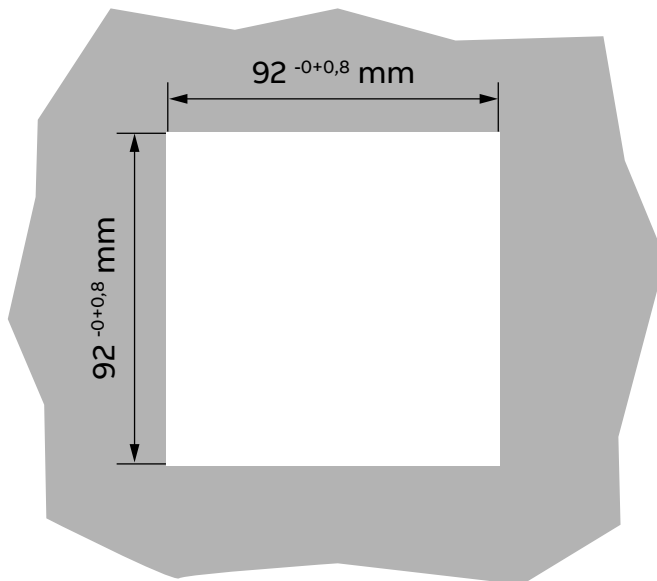

### 3.5. Technical data

<b>Auxiliary power supply</b>	
Voltage	100-230 V AC/DC $\pm 15\%$
Frequency	50 - 60Hz $\pm 5\%$
Power consumption	5VA max
Installation category	CAT III 300V class per IEC 61010-1 edition 3
Protection fuse	T1 A-277 VAC

<b>Measurement accuracy</b>	
IEC 61557-12	IEC 61557-12 PMD/S/K55/1 (M1M 20, M1M 20 Modbus, M1M 20 Ethernet) IEC 61557-12 PMD/S/K55/0.5 (M1M 20 I/O)
Active energy	IEC 61557-12 Class 1 (M1M 20, M1M 20 Modbus, M1M 20 Ethernet) IEC 61557-12 Class 0.5 (M1M 20 I/O) IEC 62053-22 Class 0.5S (M1M 20 I/O)
Reactive energy	IEC 61557-12 Class 2
Active power	IEC 61557-12 Class 1 (M1M 20, M1M 20 Modbus, M1M 20 Ethernet) IEC 61557-12 Class 0.5 (M1M 20 I/O)
Reactive power	IEC 61557-12 Class 2
Apparent power	IEC 61557-12 Class 2
Voltage	IEC 61557-12 Class 0.5
Current	IEC 61557-12 Class 0.5
Neutral Current (calculated)	IEC 61557-12 Class 1
Frequency	IEC 61557-12 Class 0.1
Unbalance	IEC 61557-12 Class 0.5
Harmonics, THD (Current, voltage)	IEC 61557-12 Class 1

<b>Voltage Measurement inputs</b>	
Voltage Range	80-265 VAC(L-N)
Type	Single-phase, three-phase (3P, 3P+N)
Rated frequency	50Hz or 60Hz
Protection fuse	T1 A-277 VAC

<b>Current measurement inputs</b>	
Current input mode	Indirect insertion with CT
Rated current at secondary side of CT	1A or 5A
Range without accuracy derating	50mA-6A

#### I/O

<b>Digital Output</b>	
Number of output channels	2 (M1M 20 I/O only)
Voltage	5-48VDC
Current	2-100mA

<b>Digital Input</b>	
Number of input channels	2 (M1M 20 I/O only)
Voltage	24VDC

  

<b>Mechanical properties</b>	
Overall Dimensions	96 mm x 96 mm x 85 mm
IP degree of protection (IEC 60529)	Front: IP51 Terminals: IP20
Max. weight	345g

<b>Climatic conditions</b>	
Operating temperature	-5 to 55 °C (K55 IEC61557-12)
Storage temperature	-25 to 70 °C (K55 IEC61557-12)
Environment	It is prohibited to use in the environment containing H <sub>2</sub> S, Cl <sub>2</sub> , NH <sub>3</sub> and other harmful gases
<b>Communication protocol</b>	
<b>Modbus RTU</b>	<b>M1M 20 MODBUS, M1M 20 I/O</b>
Communication interface	RS485 with optical isolation
Baud rate	9.6, 19.2, 38.4, 57.6, 115.2 kbps
Parity number	Odd (1 stop bit), Even (1 stop bit), None (1 or 2 stop bits)
Address	1-247
Connector	3 pole terminal
<b>Modbus TCP/IP</b>	<b>M1M 20 ETHERNET</b>
Protocol	Modbus TCP/IP
Communication interface	RJ45
<b>Standards</b>	
Power metering and monitoring devices (PMD)	IEC 61557-12
EMC	IEC 61326-1
Electrical safety	IEC 61010-1

## 4. Installation

### 4.1. Assembly

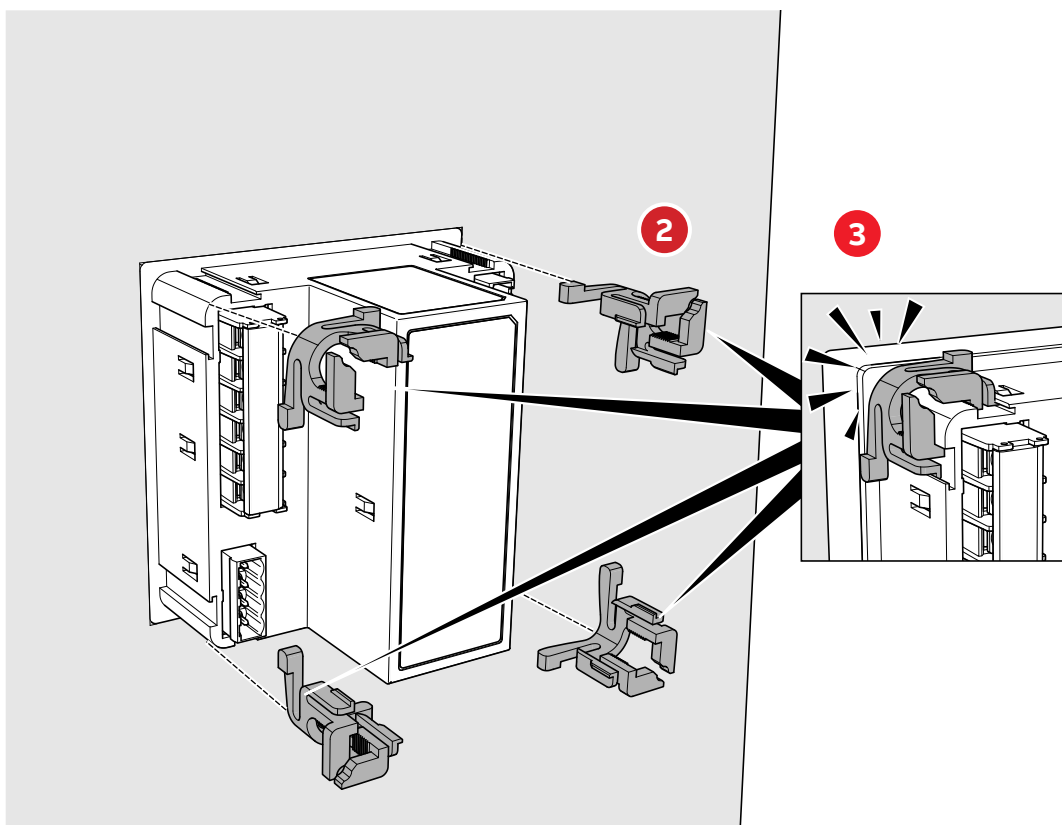
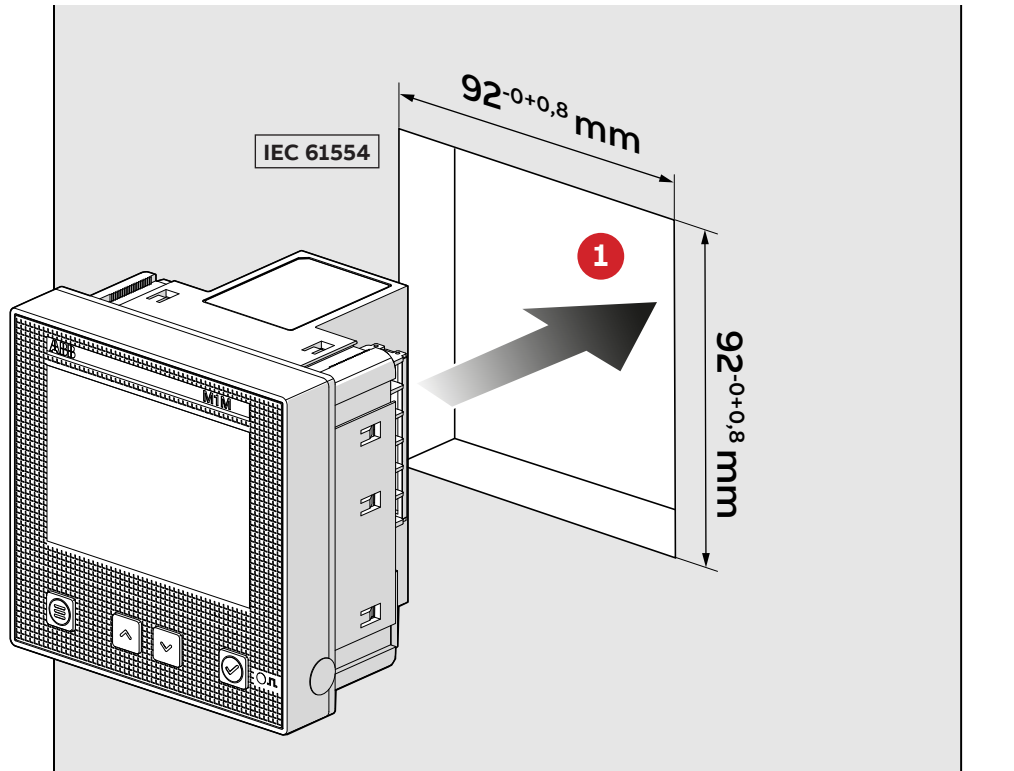

## 4.2. Disassembly

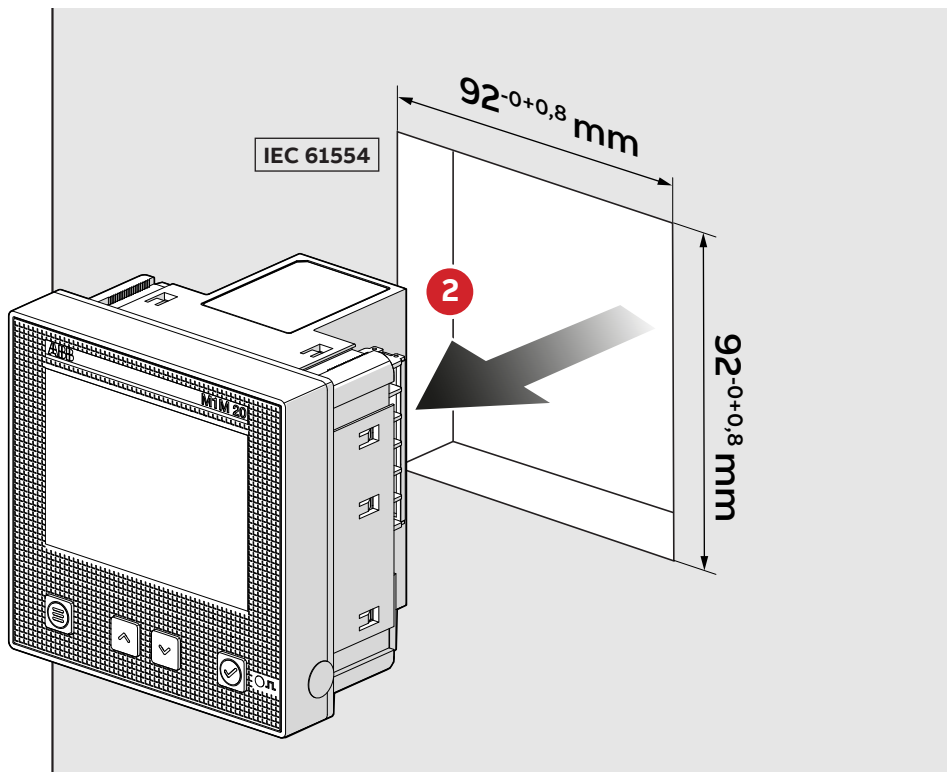
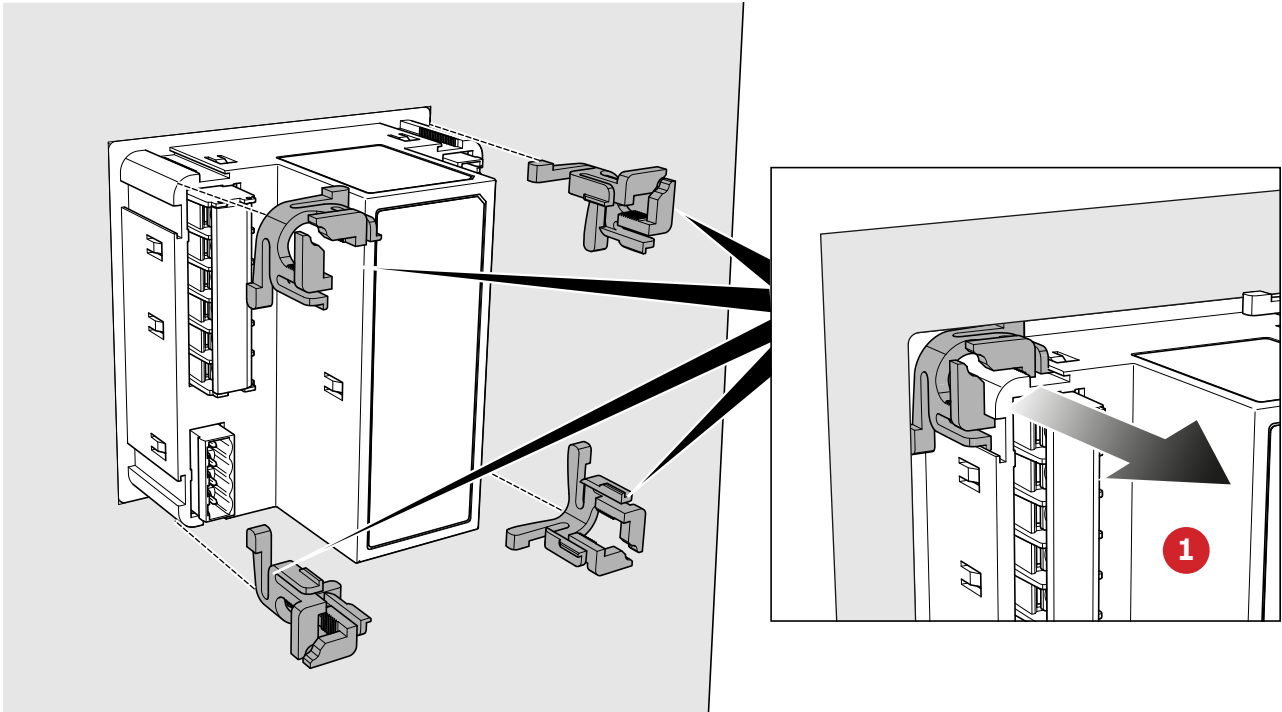

### 4.3. Wiring diagrams

The operations to carry out for the correct connection of the device, based on the type of electric line available, are described in this section.



The installation and the cabling of the device must be carried out by qualified personnel.



Danger of electrocution, burning and electric arc. Use the personal protection devices suitable to adhere to the current regulations governing electrical safety. Prior to carrying out any connections check the sectioning of the electric supply with the voltage detection device.

- M1M 20 ETHERNET

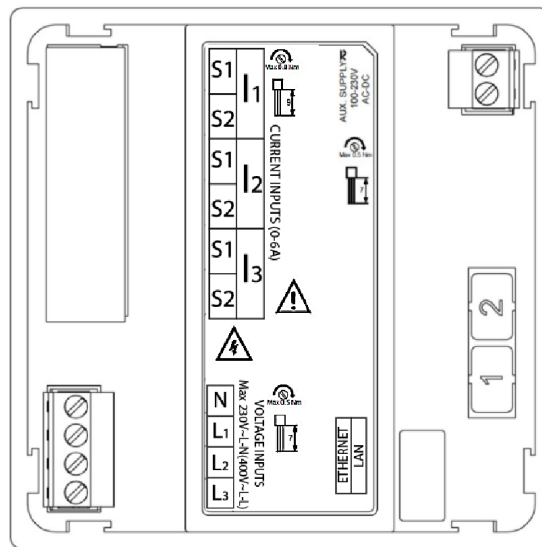

- M1M 20 I/O

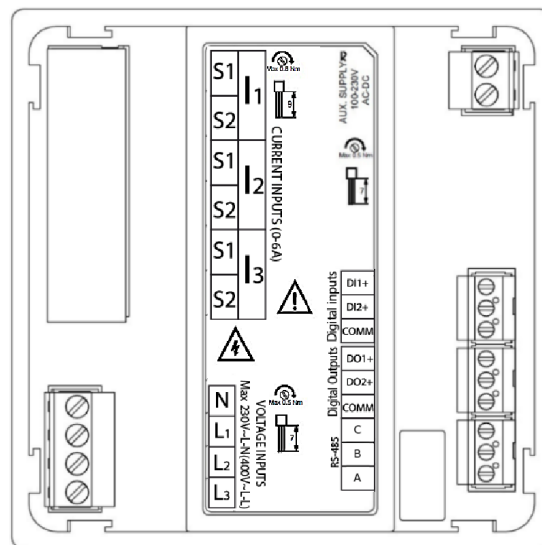

- M1M 20 MODBUS

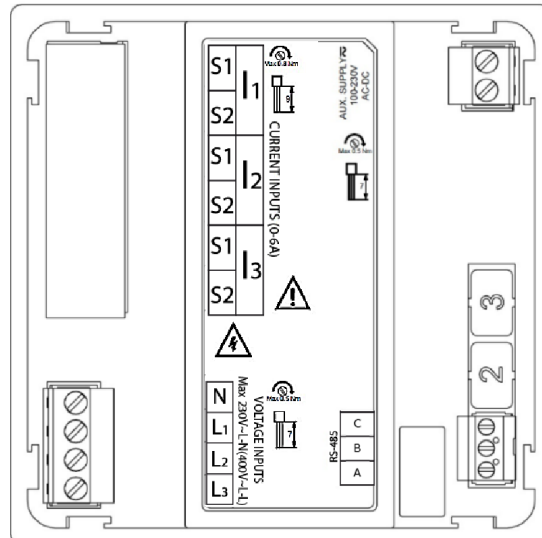

- M1M 20

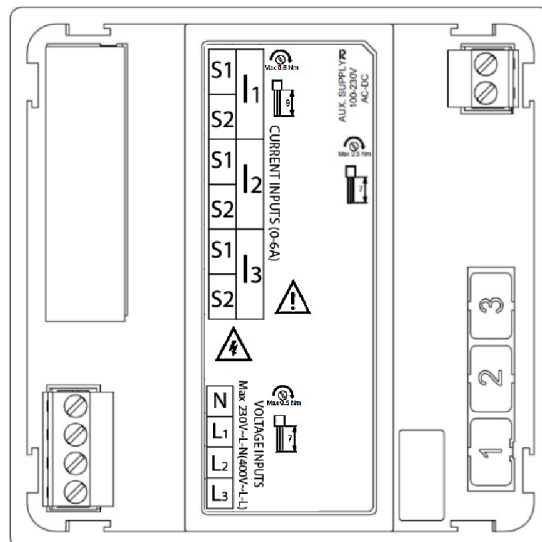

### Type of network

M1M 20 can be used on different type of network (please refer to chapter “7.Configuration (CONF)” for the configuration on the device).

According to the type of network that has been chosen, the parameters visualized on the device HMI change.

Below the wiring diagrams are shown:

- 3-phase 4-wire network with 3CTs (3N3T)

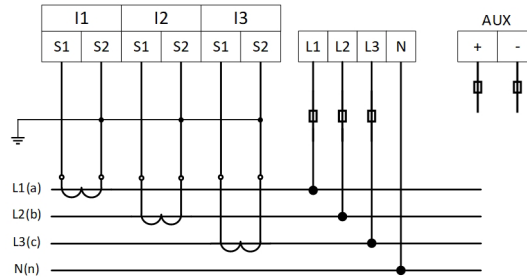

- 3-phase 3-wire network with 3CTs (3 3T)

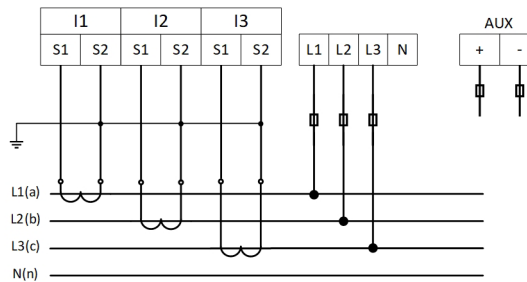

- 3-phase 3-wire network with 2CTs (3 2T)

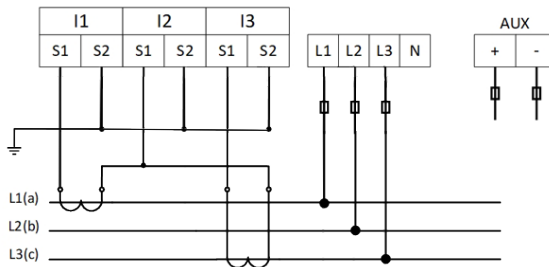

- 3-phase 3-wire network with 1CT (3 1T)

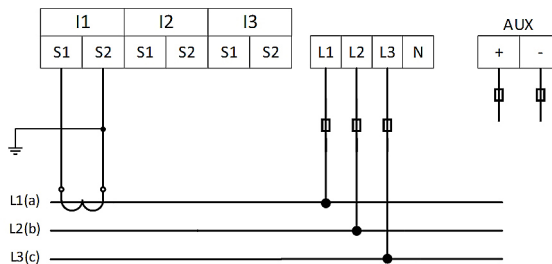



- 1-phase 2-wire network with 1CT (1N1T)

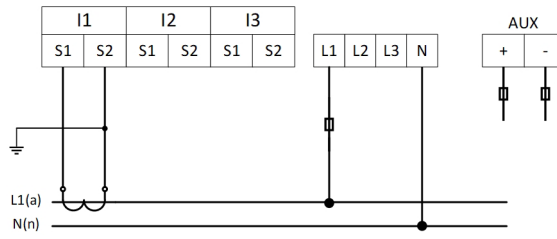

- Digital outputs (M1M 20 I/O only)

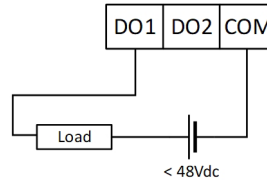

- Digital inputs (M1M 20 I/O only)

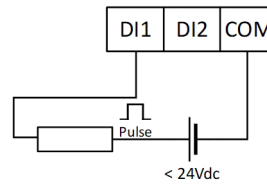

## 5. Access to device

This chapter gives a detailed introduction of the device's HMI, including how to read data and configure related parameters.

### 5.1. Display

#### Front panel

The front panel of M1M is shown below:

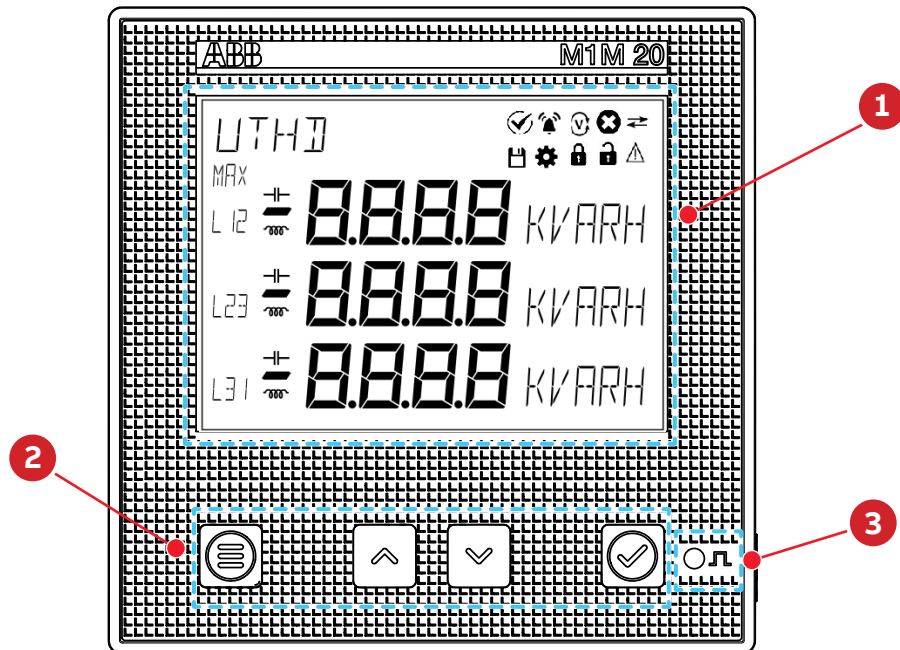

#### Operator panel

- |   |                  |
|---|------------------|
| 1 | Display          |
| 2 | Function buttons |
| 3 | Energy pulse LED |

## Display content

Display is divided into 8 different areas, as shown in the figure below:

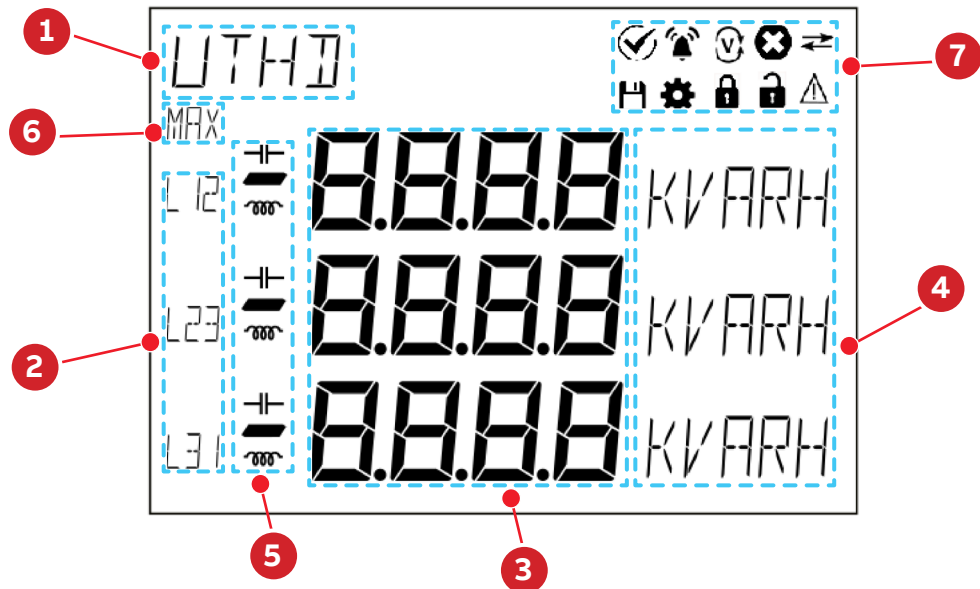

N	Area	Description
1	Title	Title of the content displayed on each screen, including MENU, READ and CONF...
2	Phase	The corresponding phase of the measured value displayed, such as L1, L2, L3, L12 and L23...
3	Measurements	Specific measured value
4	Magnitude/Unit	Magnitude includes E, K and M; Unit includes V, A, W and WH...
5	Load type	Inductive load and capacitive load
6	Additional info	Additional info regarding the displayed page.
7	Icons	Indicating various types of state; and for further details, see the table below

Icon	Description
	Notification of alarm
	Correct phase sequence
	Reverse phase sequence
	Notification of error
	Communication signals sent
	Communication signals received
	Configure parameters
	Device locked, and parameters non-configurable
	Device unlocked, and parameters configurable
	Notification of warning

## 5.2.Buttons

Each M1M is provided with 4 pushbuttons as per below picture::

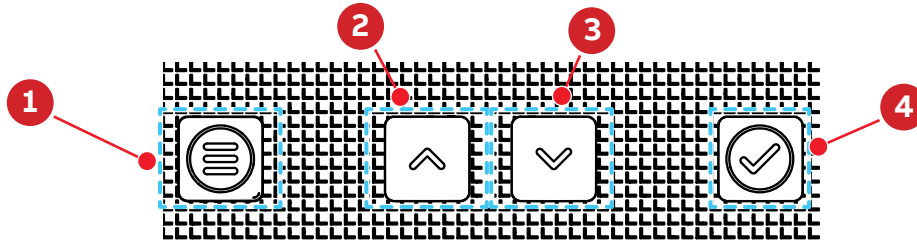

Functions of each button might change according to the displayed page on the meter. See below for a complete description:

#	Button	Functions
1	Menu	Go to the main menu; go back; or return to the default screen
2	Up	Page up and enter numerical value in cyclic and ascending way and decimal point; and when pressed continuously, page is up continuously or numerical value ascends automatically
3	Down	Page down and move to higher-order numerical value and confirm the decimal point; and when pressed continuously, page is down or numerical value moves to higher order continuously until zero clearing
4	Enter	Go to the next menu, confirm the numerical value or option input, and read the average of the parameter measurements

### 5.3.Data entry

Some of the pages require the entry of numerical characters (0-9) in the Configuration mode. In these cases the display will show an active field identified by a flashing number.

#### Data entry procedure

The data entry procedure is as follows:

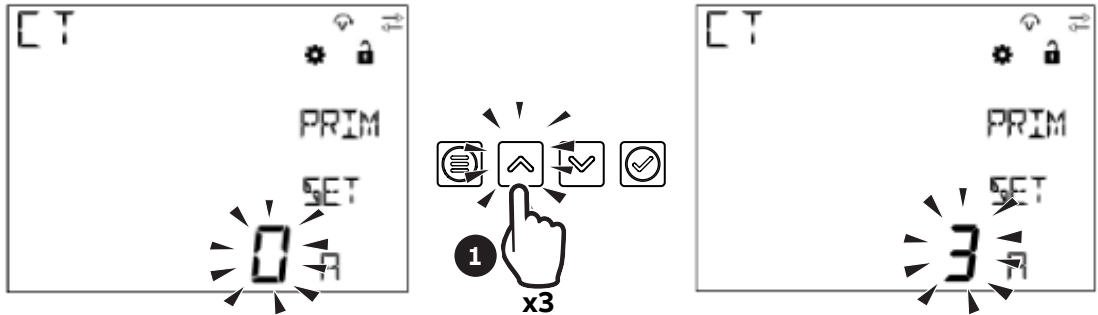

1. Press “Up” to increase the numerical characters from 0 to 9, until the required character is obtained.

• How to: Go back to a previous number

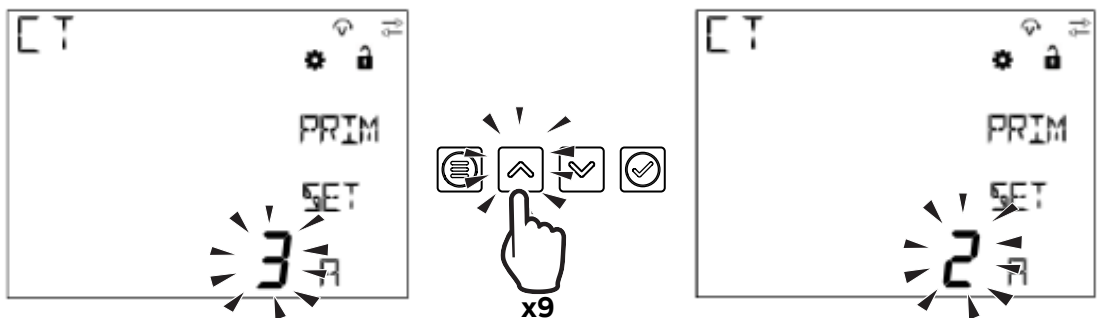

If during the data entry the desired number is exceeded by mistake, it is needed to increase the displayed number until data entry starts again from 0.

• Add a second digit

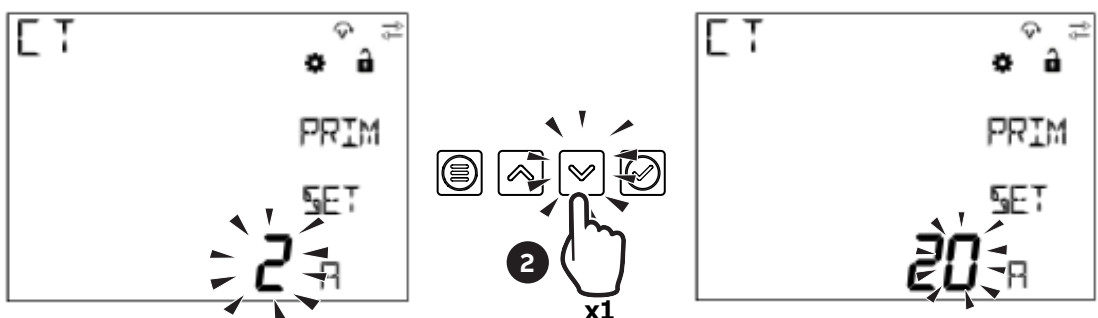

2. Press “Down” to move the cursor in order to add a second digit to the number;

• How to: Enable the comma

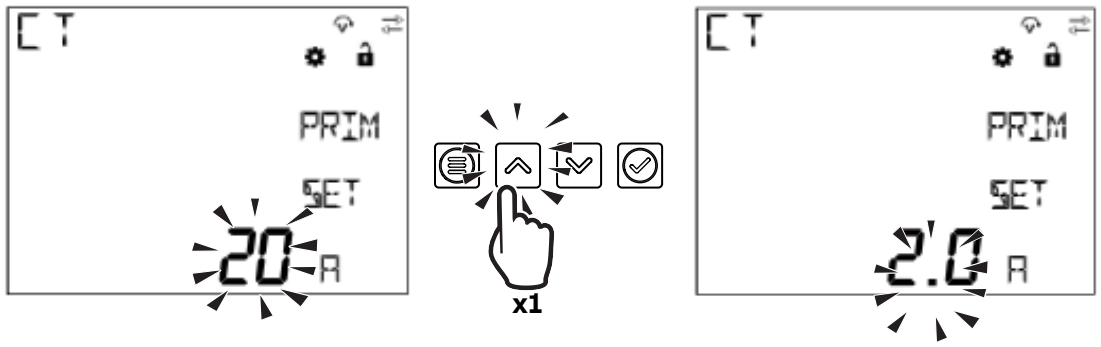

Some device configurations allow entering the comma. Comma can be displayed by increasing the number with "Up", after character 9 and before data entry starts again from character 0.

• Confirm number

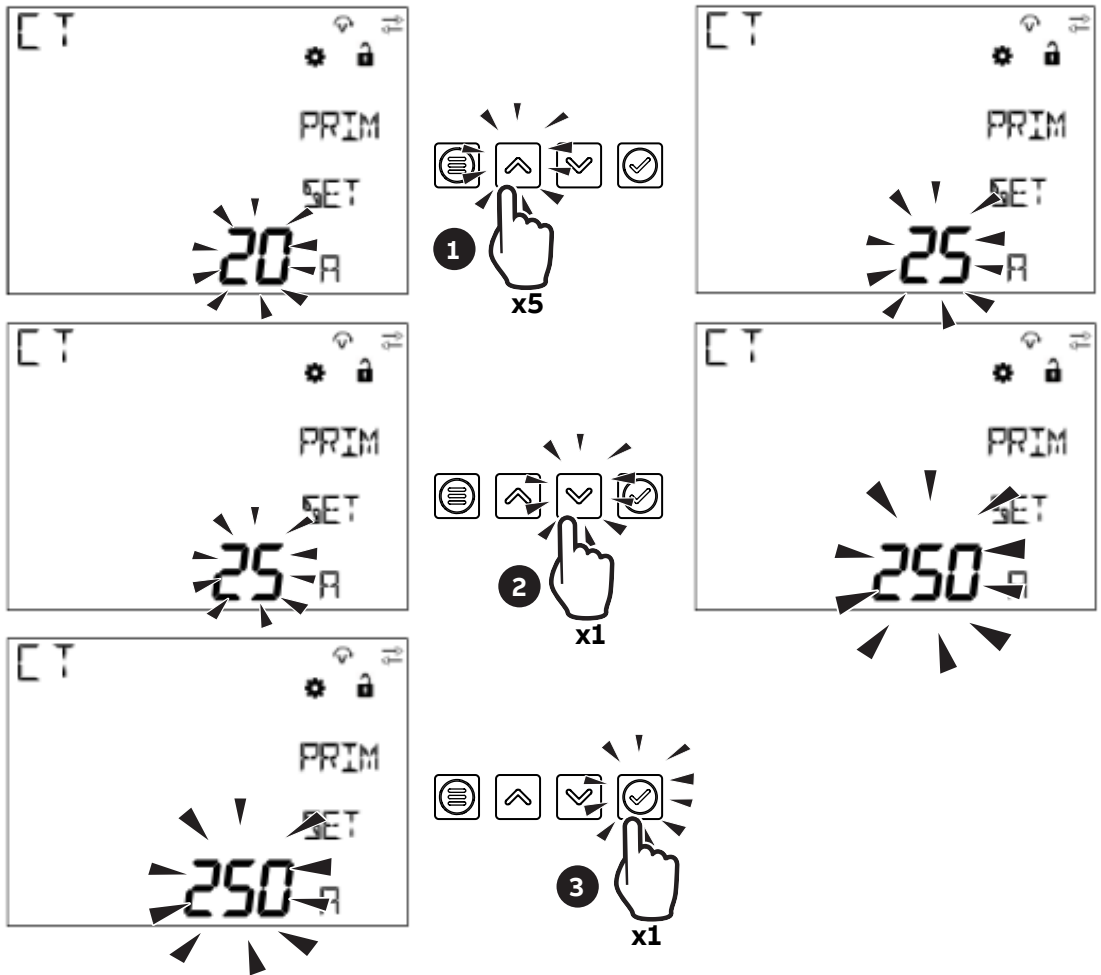

3. Repeat the operations described in steps 1 and 2 until the desired number is obtained, press "Enter" to confirm the number.

**• How to: Enter the magnitude**

Some device configurations allow entering the magnitude.

Once the number has been entered as after step 3, keys “Up” and “Down” allow enabling the magnitude “K” (kilo) or not. Press “Enter” to confirm the magnitude. Follow the steps below when the buttons are used to enter numbers:

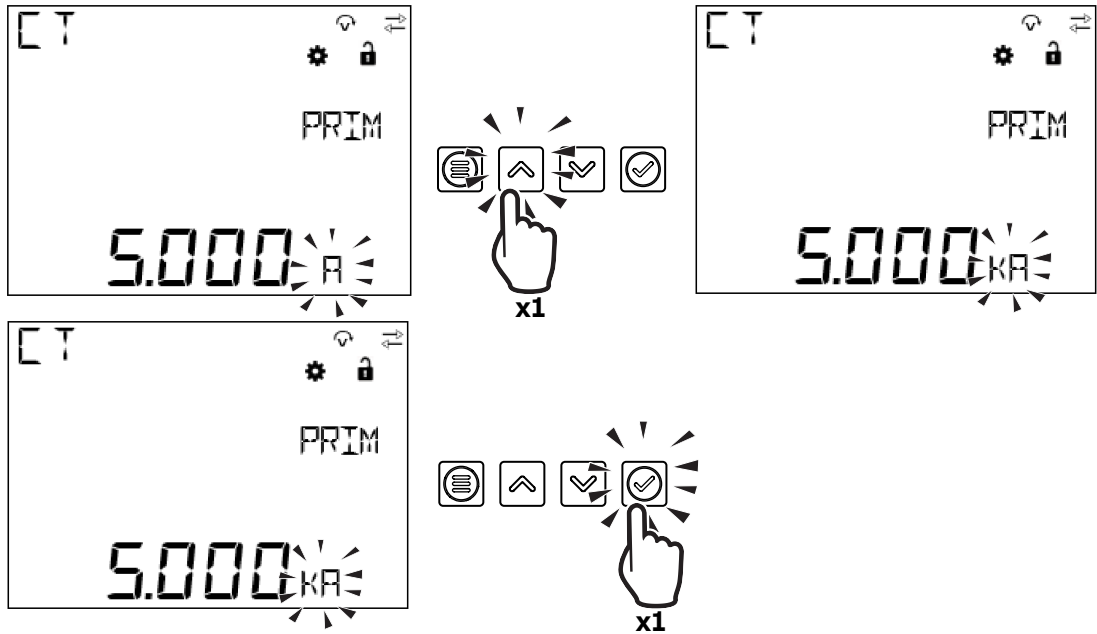

## 6. First commissioning

When the device is started up for the first time, the basic parameters need to be set, and the wizard program will guide the user to configure the device by following the steps below:

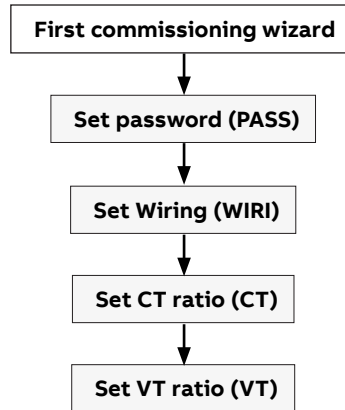

### 6.1. Password for the first use (PASS)

A password can be set by the user to protect the Configuration menu and avoid any unwanted modification to the device settings.



At the first use it is mandatory to define a password.

The password comprises 4 digits, and Button “Up” and Button “Down” can be used to enter numbers, and Button “Enter” can be used to confirm the user’s settings and Button “Menu” used to drop the user’s settings.



In order to disable the password, please set the new password as **0000**.

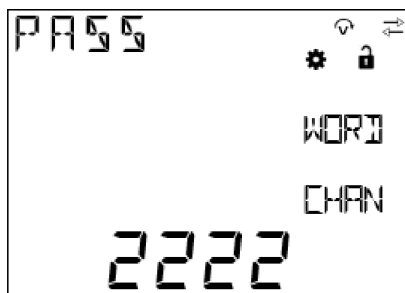

The password can be changed this way:

1. go to **CONF/UNIT/PASS**,
2. press “Enter” to start changing password.



## 6.2. Wiring (WIRI)

In order to configure the type of network it is needed to choose one of the available options according to the installation conditions.

☰ > CONF > INSTL > WIRI

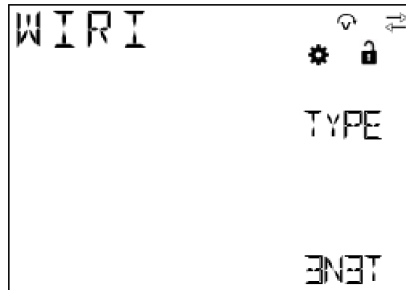

1. Scroll the list of fields “Up” or “Down”
2. Select one option by pressing “Enter”

Type	Description
3N3T	Three-phase, four-wire and 3 CTs
3 3T	Three-phase, three-wire and 3 CTs
3 2T	Three-phase, three-wire and 2 CTs
3 1T	Three-phase, three-wire and 1 CT
1N1T	Single-phase, two-wire and 1 CT

## 6.3. CT ratio (CT)

M1M is capable to measure current only via indirect connection by means of current transformers CTs.../5A or .../1A.

It is needed to set the transformation ratio of the installed current transformers.

In order to configure the current transformers ratio it is possible to set the primary (PRIM) and secondary (SEC) of the current transformer.

☰ > CONF > INSTL > CT

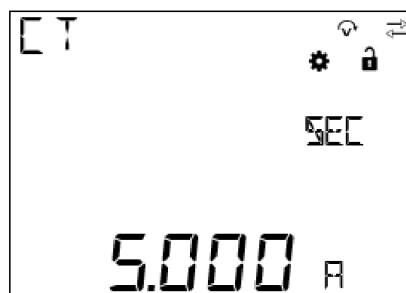
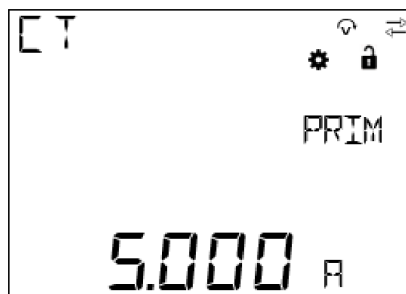

1. When the number of the primary CT is set, press Button “Enter”
2. Use Button “Up” and Button “Down” to select the magnitude
3. Press button “Enter” to confirm the setting of the primary CT
4. Press button “Down” to go to the setting of the secondary CT
5. Select the secondary CT among 1 and 5A
6. Press button “Enter” to confirm the setting of the secondary CT

### 6.4.VT ratio (VT)

M1M is capable to measure voltage via direct connection up to 265 VL-N, or via indirect connection by means of voltage transformers.

In order to configure the voltage transformer ratio it is needed to enter manually the values of both primary (PRIM) and secondary (SEC).

 > CONF > INSTL > VT

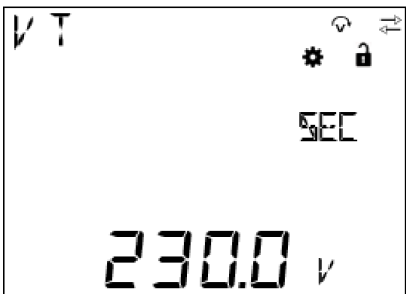
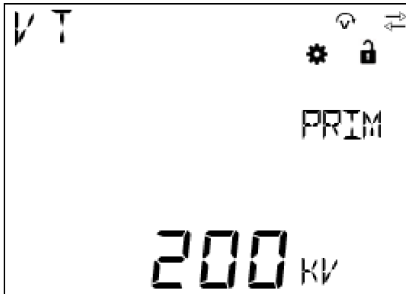

1. When the number of the primary VT is set, press Button "Enter"
2. Use Button "Up" and Button "Down" to select the magnitude
3. Press button "Enter" to confirm the setting of the primary VT
4. Press button "Down" to go to the setting of the secondary VT
5. When the number of the secondary VT is set, press Button "Enter"
6. Press button "Enter" to confirm the setting of the secondary VT



In case of direct insertion without voltage transformers, please set VT ratio as 230/230 (default)



## 7.Configuration (CONF)

When the user goes to the CONF section, Icon  will be displayed.

When entering the CONF section, in order to change any configuration of the device, it is mandatory to enter the password. The password is valid as soon as the user remains in the Configuration section and for max. 5 minutes of idle. After quitting the Configuration section, it is needed to enter again the password.

In case of wrong entering of the password for three times in a row, user will have to wait for 5 minutes until he can enter the password once again.

In order to read only the configurations, it is possible to simultaneously press “Enter” and “Up” buttons.

After the user enters the password to unlock the device, Icon  will be displayed and icon  will disappear.

CONF includes the following menus:

Menu	Description
UNIT	Settings related to the device itself
INSTL	Settings related to the installation conditions
I/O	Definition of I/O type of the M1M version
ALARM	Definition of alarm conditions
COMM	Settings related to the embedded communication protocols of the M1M version

### 7.1.Unit (UNIT)

UNIT includes the following sub-menus:

Menu	Description
PASS	Change the existing password
RESET	Full or partial reset of the meter
INFO	Device information
BRT	Adjust the brightness of the display

#### Modify password (PASS)

PWD shares the same interface and setting way with password setting. For details, see “6.1.Password for the first use (PASS)”.

 > CONF > UNIT > PASS

#### Reset (RESET)

 > CONF > UNIT > RESET



If the user selects “YES” and presses Button “Enter”, all parameters will be reset, i.e. restoring all parameters to their factory default.

RESET sub-menu includes the following pages:

Menu	Description
RESET FACTORY	Reset factory settings
RESET ENRG	Clear energy value
RESET NOTF	Clear notifications

#### • RESET FACTORY

Reset Factory settings restores parameters to default values, including communication parameters, input and output, notifications, etc.

 > CONF > UNIT > RESET > FACTORY

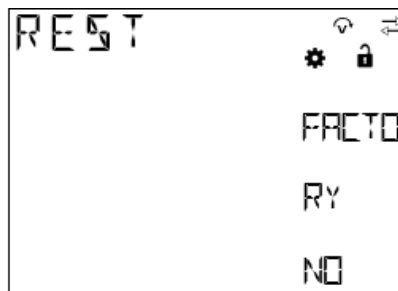

**• RESET ENRG**

Reset energy will clear the energy to 0.

☰ > CONF > UNIT > RESET > ENRG

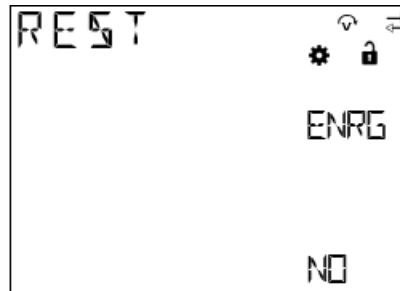
**• RESET NOTF**

All notifications will be cleared after the Reset Notification, including alarms, warnings, and faults.

☰ > CONF > UNIT > RESET > NOTF

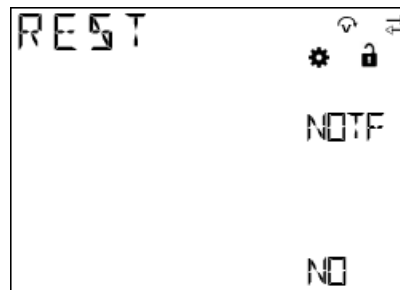

**Device info (INFO)**

INFO includes firmware version, product model and peripheral functions, etc.

☰ > CONF > UNIT > INFO

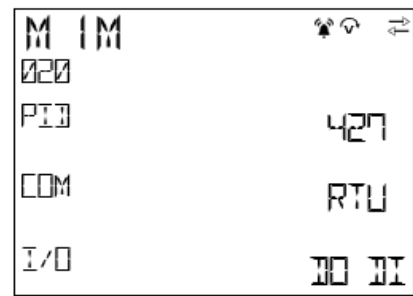
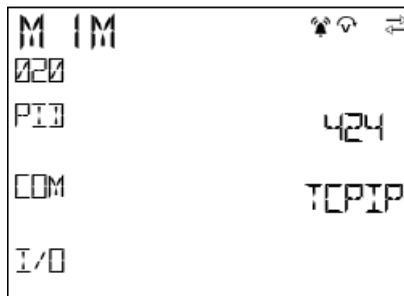
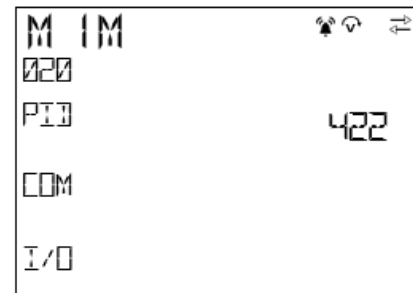
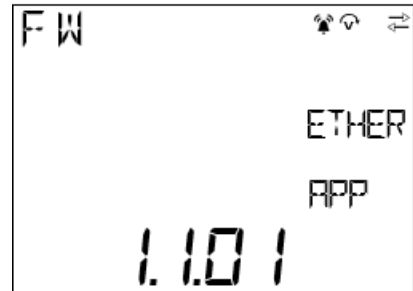
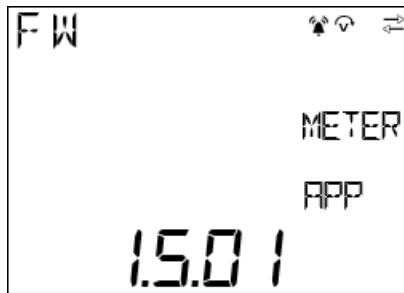

Menu	Description
FW	Firmware version
CNFC	Parameter configuration counter
M1M	Product model and peripheral functions

**Brightness (BRT)**

The parameter is used to adjust brightness of the display.

☰ > CONF > UNIT > BRT

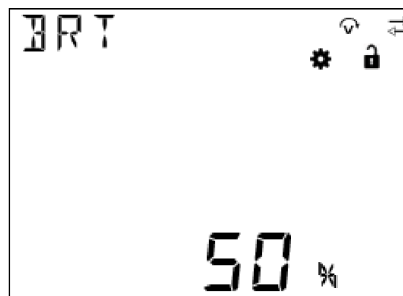

The default of this parameter is 100%, and the adjustable range is 10%-100%.

## 7.2.Installation (INSTL)

INSTL includes the following sub-menus:

Menu	Description
WIRI	Set the type of network and number of wires on which the device is installed
CT	Set the ratio of current transformers for current measurement
VT	Set the ratio of voltage transformers for voltage measurement, if any

The three items must be set during the first startup. For details, see “6.2.Wiring (WIRI)”, “6.3.CT ratio (CT)” and “6.4.VT ratio (VT)”.

## 7.3.Input / output (I/O)

In this section it is possible to configure I/O slots of the meter.

Please refer to the table in “3.3.Versions” for the detail of I/O types per each M1M.

I/O includes the following sub-menus:

Menu	Description
DO	Digital output
DI	Digital input
PULS	Specific settings in case of pulse output

### Digital Output (DO)

All DOs can be configured as alarm output (ALARM) or pulse output (PULSE).

☰ > CONF > IO > ⏏

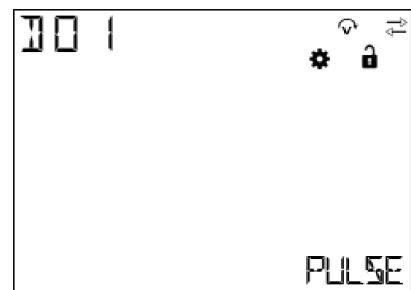
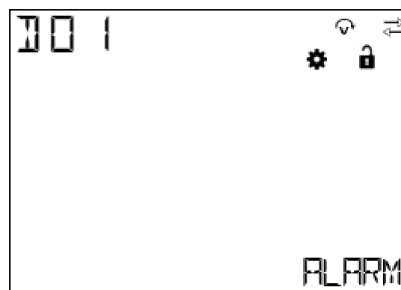

**Digital input (DI)**

DI can monitor the current state on one hand, and record the number of input pulses on the other hand. This parameter can clear the number of pulses recorded.

☰ > CONF > IO > DI

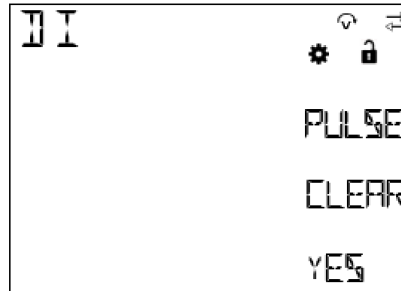

When “YES” is selected and Button “Enter” pressed, the system will clear all pulses recorded by the DI. DI pulse count requires a factor to be set, which can be in the range of 1 to 9999

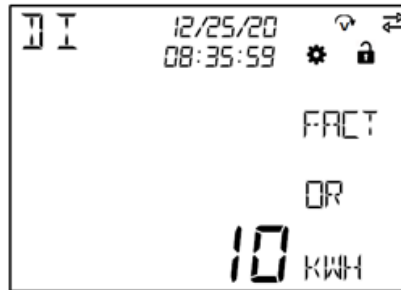

Options	Description
-	None
WH	Active energy
KWH	
MWH	
VARH	Reactive energy
KVARH	
MVARH	
VAH	Apparent energy
KVAH	
MVAH	



### Pulse settings (PULS)

PULS includes selection of energy variables of panel LED indicator, energy pulse output ratio, and selection of energy variables of the DO set as PULSE.

 > CONF > IO > PULS

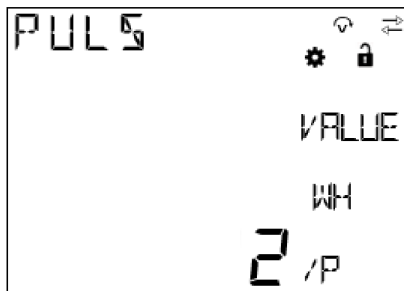

The optional output energy variables of LED indicator and DO include:

Electricity Variable	Description
PEN	Active energy
QEN	Reactive energy
OFF	Off



The setting range of pulse output ratio is: 0.001 ... 9999. The formula guiding this parameter setting is:  
**1** pulse = **X** Wh (varh/VAh)  
**X** is the set number.

### 7.4.Alarms (ALM)

ALARM configuration is used to get info on threshold violations of specific parameters. When the measurement quantity exceeds the limit, an alarm will be given to prompt users to make corresponding treatment measures in time.

Each alarm can only be triggered when certain conditions are met. The following graph describes the process of triggering and releasing an alarm:

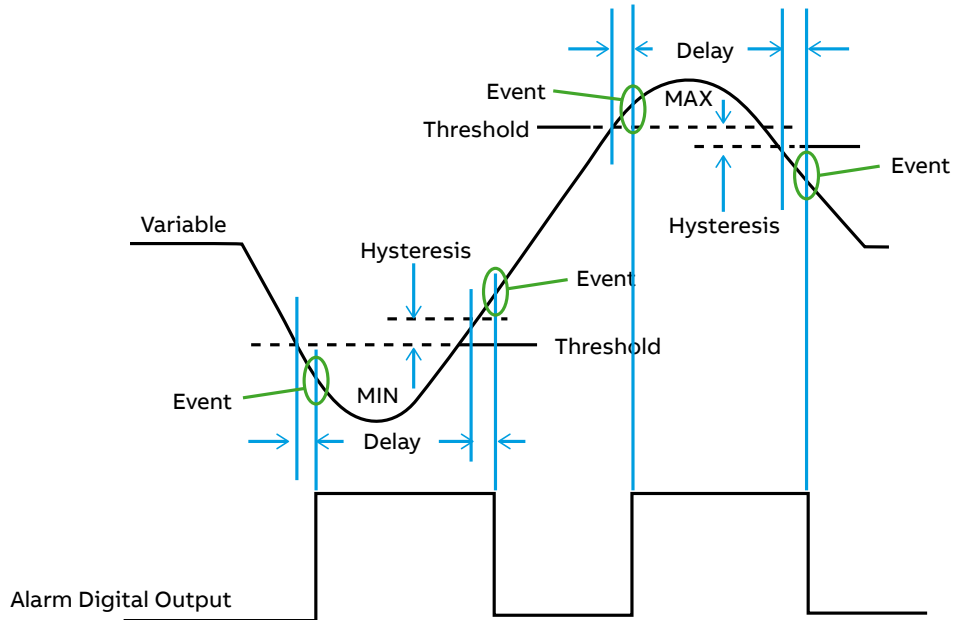

When the value of the alarm variable exceeds the threshold and the delay, the alarm will be generated; and when the alarm variable recovers to the normal range and exceeds the hysteresis and delay, the alarm will be released. Alarm can be connected to certain DO to control the alarm signal output at the DO. If the alarm is stored in flash, it can be viewed later in the read data menu. When the device is in alarm state, ICON 📢 will be displayed.

Each M1M provides up to 15 alarms; following parameters are available:

Menu	Description
NUM	Select which alarm will be edited, max 15 alarms can be selected
VARIABLE	Select alarm variable
PHASE	Select the phase of alarm variable
TYPE	Type of alarm: cross-up (MAX) or cross-down (MIN)
SETPOINT	Set threshold
DELAY	Delay time
HYSTERESIS	Set hysteresis
LOG	Read only - Alarms are not logged on M1M 20
PORT	Select digital output port for alarm

## NUM

Select an alarm to edit, which will be added to the alarm list if it has been edited.

☰ > CONF > ALM > NUM

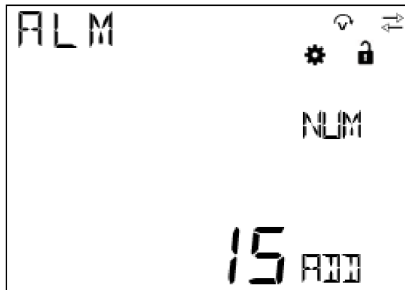

- “ADD” indicates that the alarm is not yet present. If it needs to be added, press Button “Enter” to go to the event and configure the subsequent parameters.

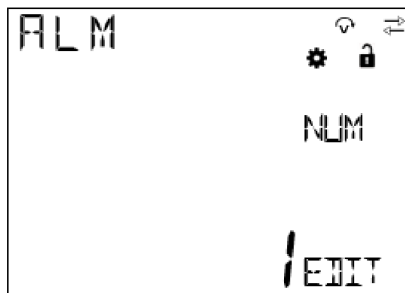

- “EDIT” indicates that the alarm is already present. If it needs to be modified, press Button “Enter” to go to the event and modify the configurations.



If certain event needs to be deleted from the alarm list, the alarm variable is selected as “NONE”. For details, see “**VARIABLE**”.

**VARIABLE**

Select one variable as alarm variable.

☰ > CONF > ALM > VARIABLE

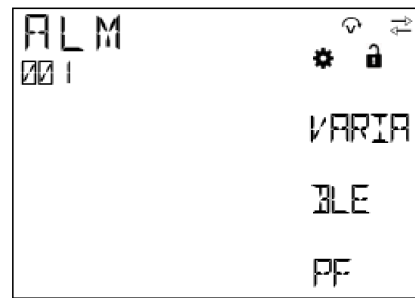
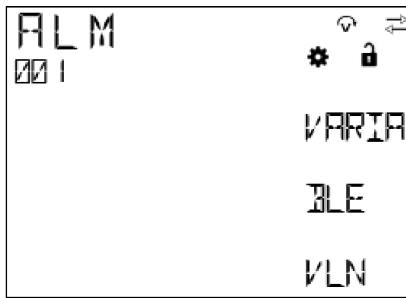

Variable	Description
VLN	Phase voltage
VLL	Line voltage
I	Phase current
IN	Neutral current
P	Active power
Q	Reactive power
S	Apparent power
PT	Total active power
QT	Total reactive power
ST	Apparent power
PF	Power factor
PFT	Total power factor
F	Frequency
THDV	Total harmonic distortion of voltage
THDI	Total harmonic distortion of current

**PHASE**

When a variable is selected, a specific phase of the variable needs to be selected.

☰ > CONF > ALM > PHASE

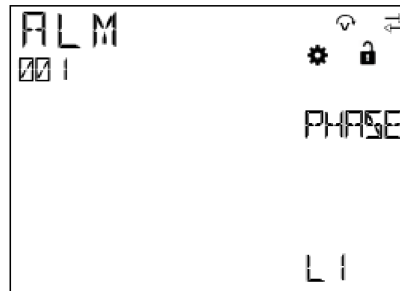

Phase	Description
L1	Phase 1
L2	Phase 2
L3	Phase 3
L123	All three phases
TOT	Total phase



Different variables contain different phases, so the phase selection depends on the variable selected.

**TYPE**

TYPE includes MAX (cross-up event) and MIN (cross-down event).

☰ > CONF > ALM > TYPE

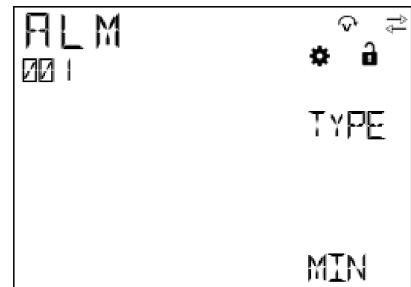
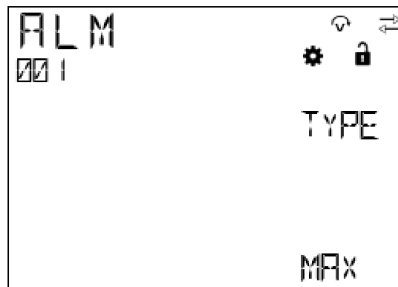

### SETPOINT

SETPOINT includes numerical value and magnitude. Different variables correspond to different thresholds, magnitudes, and units, and you need to select variables before setting SETPOINT.

☰ > CONF > ALM > SETPOINT

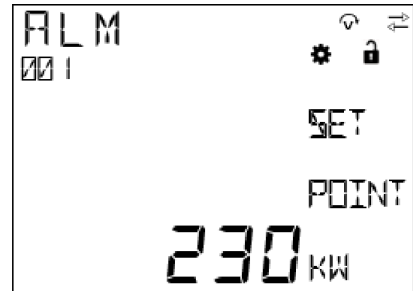
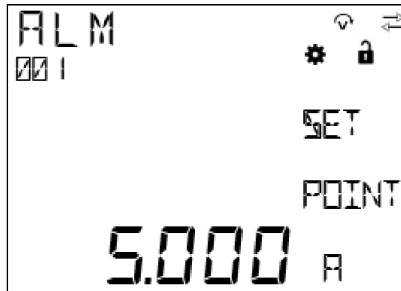

After the number is set, it is needed to use Button “Up” and Button “Down” to adjust the magnitude.

### HYSTERESIS

HYSTERESIS is a percentage value, and its setting range is 0%-50%.

☰ > CONF > ALM > HYSTERESIS

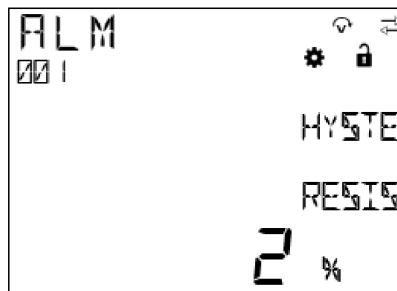

### DELAY

DELAY is used to verify whether the variable value really exceeds the limit or is recovered, and its setting range is 1-255s.

☰ > CONF > ALM > DELAY

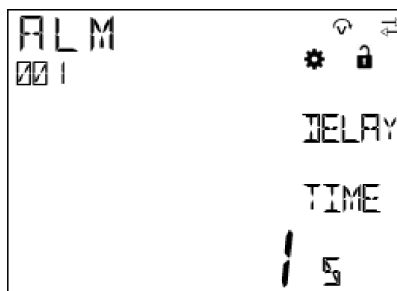

**LOG**

All alarms are by default in UNLOG mode, meaning that alarms are not stored in any flash memory. However, it is still possible to read out the alarms in: *READ* > *NOTF* > *ALM*

 > *CONF* > *ALM* > *LOG*

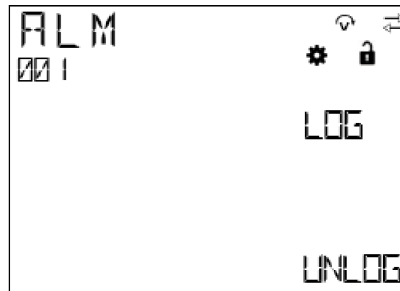

After device restart, all alarms will be erased and it will not be possible to retrieve them.

**PORT**

Each alarm event can be connected with certain DO, and different alarms can be connected to the same DO.

 > *CONF* > *ALM* > *PORT*

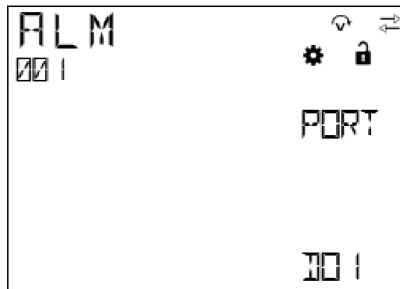

The optional DOs include DO1, DO2 and OFF.



Only the DOs configured as alarm output can appear in the list. For details, see “7.3.Input / output (I/O)”.

### 7.5.Communication (COMM)

Communication menu allow to set all the parameters related to the communication protocol available for a specific product version. The embedded communication protocol varies according to the different product versions. Please refer to “3.3. Versions” for the details on the embedded communication protocols.

Based on product version following configuration menus are available:

Communication Protocol	Parameter	Description
Modbus RTU	ADDR	Bus address
	BAUD	Baud rate
	BYTE	Byte format
Modbus TCP/IP	DHCP	Enable/disable DHCP function
	IP	IP address
	MASK	Subnet mask
	GW	Default gateway

In the communication process, whichever communication mode is selected, when the device receives data, Icon ← will appear and flicker; and when the device sends data, Icon → will appear and flicker.

#### Modbus RTU (M1M 20 Modbus, M1M 20 I/O)

• ADDR

For the devices that adopt the Modbus RTU protocol, a unique address on the bus needs to be set.

☰ > CONF > COMM > ADDR

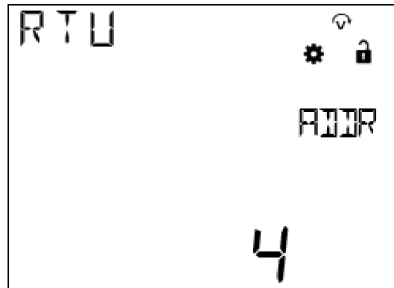

**i** The address range is 1-247.

• BAUD

BAUD represents data transmission rate. The higher the BAUD, the faster the data transmission.

☰ > CONF > COMM > BAUD

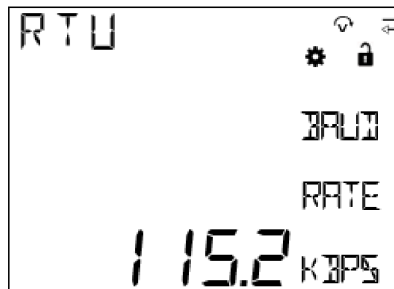

**i** The optional Baud rates include 9600, 19200, 38400, 57600 and 115200 bps.



• **BYTE**

BYTE comprises three parts – bits per byte, parity bit and stop bit.

☰ > CONF > COMM > BYTE

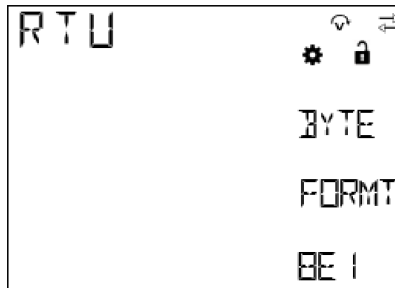

The optional byte formats include:

BYTE	Description
8E1	8 even parity bits and 1 stop bit
8O1	8 odd parity bits and 1 stop bit
8N1	8 No Parity bits and 1 stop bit
8N2	8 No Parity bits and 2 stop bits

**Modbus TCP/IP (M1M 20 Ethernet)**

• **DHCP**

If DHCP is set as “YES”, it indicates that the IP address and subnet mask assigned by the host will be used.

☰ > CONF > COMM > DHCP



The default state of DHCP is “NO”, i.e. turned off.

• **IP**

IP comprises 4 segments. Each time Button “Enter” is pressed, the next segment can be set.

☰ > CONF > COMM > IP

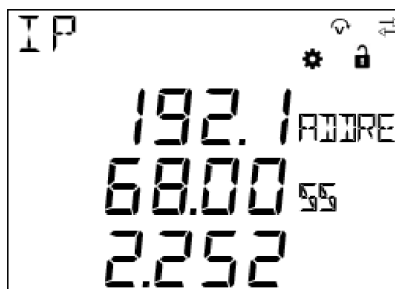

The default IP address is: 192.168.2.252.

The device and the host must share the same network, or their communication is not possible.

• MASK

MASK indicates the LAN segment. Only the devices that have the same subnet mask within the same LAN can communicate with each other.

☰ > CONF > COMM > MASK

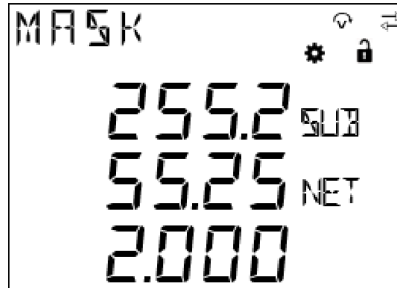

The default MASK is: 255.255.255.0.

• GW

The default GW is the node address that forwards the data package to other networks.

☰ > CONF > COMM > GW



The default GW is: 192.168.002.001.

## 8.Data reading (READ)

READ section allows to visualize all the parameters measured by M1M.

Specifically, it includes the following menus:

Menu	Description
REAL	Real-time measurements
ENRG	Energy measurements
PWQT	Power quality
I/O	State of digital input/output port
NOTF	Notification message
TIME	Timers

### 8.1.Realtime (REAL)

REAL means the real-time data of the current electric energy, including the following items:

☰ > READ > REAL

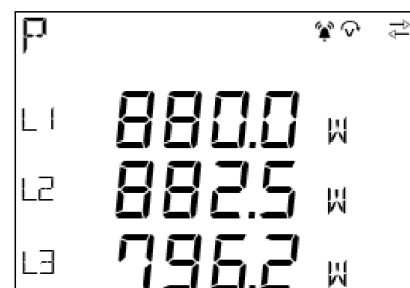
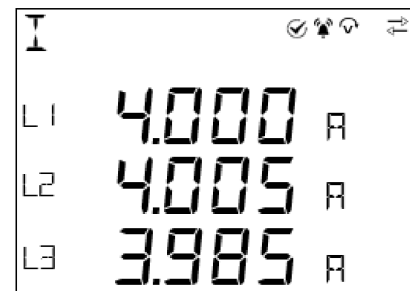
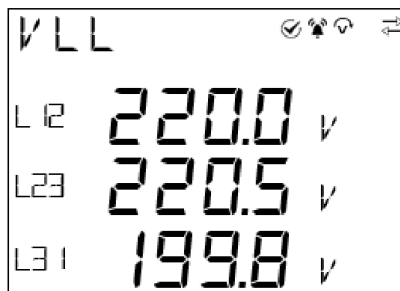
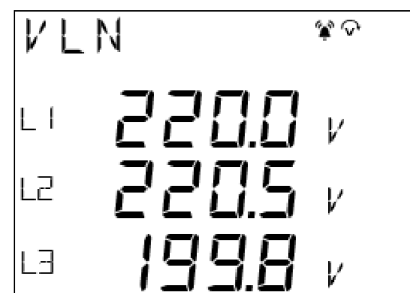
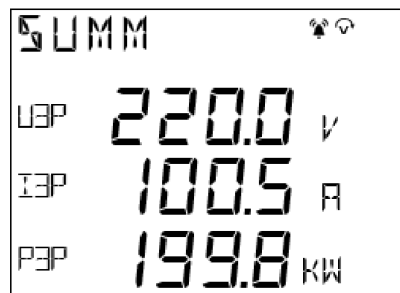

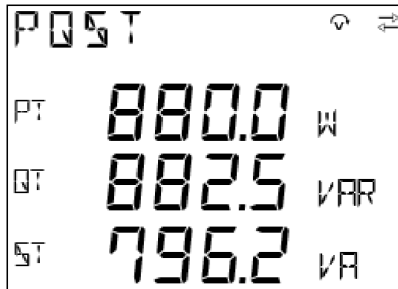
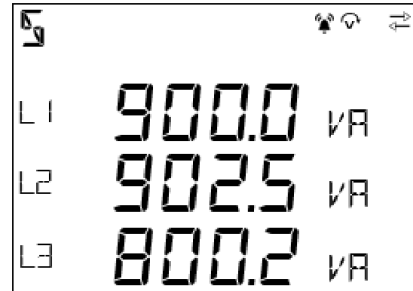
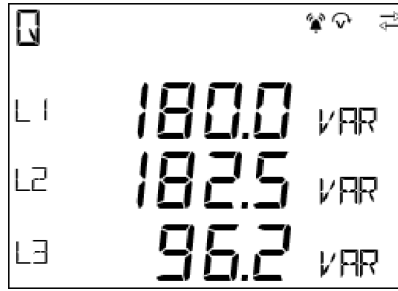

REAL	Description
SUMM	Summary data, including total three-phase voltage, three-phase current and active power
VLN	Phase voltage; when WIRI is selected as "3 3T", "3 2T" or "3 1T", this data is absent
VLL	Line voltage
I	Current
IN	Neutral current; when WIRI is selected as "3 3T", "3 2T", "3 1T" or "1N1T", this data is absent
P	Per phase active power; when WIRI is selected as "1N1T", this data is absent
Q	Per phase reactive power; when WIRI is selected as "1N1T", this data is absent
S	Per phase apparent power; when WIRI is selected as "1N1T", this data is absent
PQST	Total active, reactive, apparent power
F	Frequency

## 8.2. Energy (ENRG)

☰ > READ > ENRG

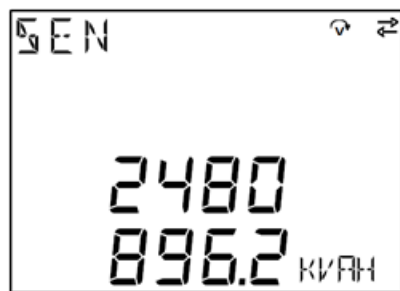
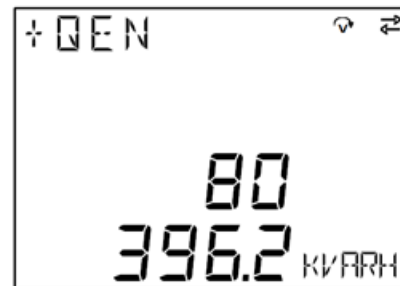
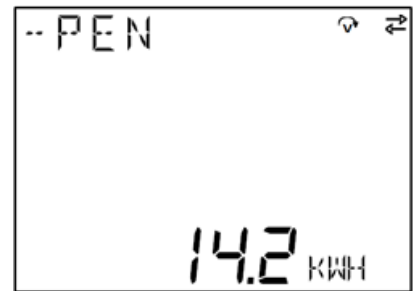
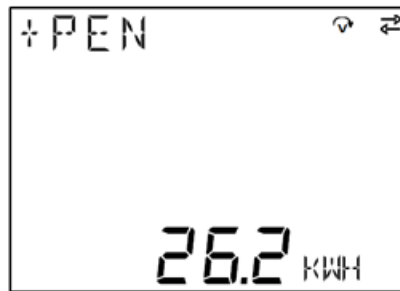

ENRG	Description
+PEN	Total imported active energy
-PEN	Total exported active energy
+QEN	Total imported reactive energy
-QEN	Total exported reactive energy
SEN	Total apparent energy

### 8.3. Power Quality (PWQT)

☰ > READ > PWQT

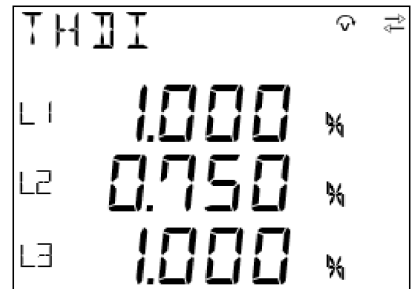
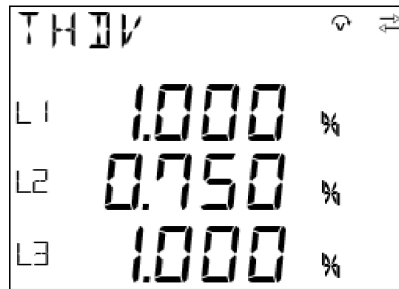
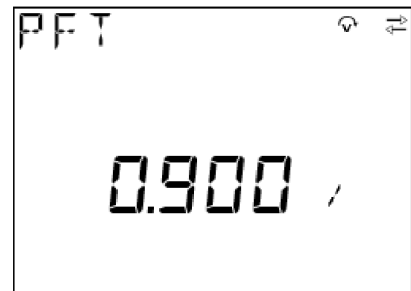
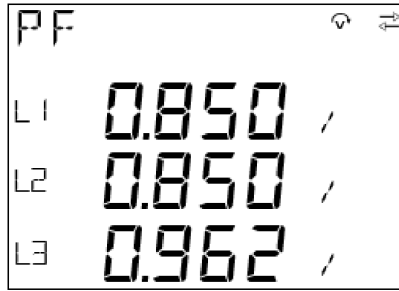

PWQT	Description
PF	Per phase power factor; when WIRI is selected as "3 3T", "3 2T", "3 1T" or "1N1T", this data is absent
PFT	Total power factor
THDV	Total harmonic distortion of voltage
THDI	Total harmonic distortion of current



Individual harmonics are present only via Modbus RTU and Modbus TCP/IP communication.

### 8.4.I/O

I/O sub-menu includes the reading of status and/or pulses for I/O, according to the product version:

Menu	Description
DO STATE	State of digital output port
DO PULSE	Pulse count of digital output port
DI STATE	State of digital input port
DI PULSE	Pulse count of digital input port



Only M1M 20 I/O is equipped with 2 Digital Inputs and 2 Digital Outputs.

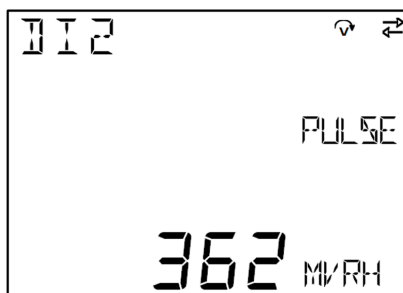
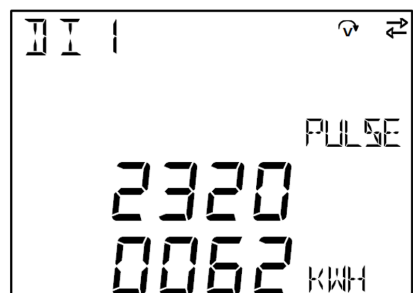
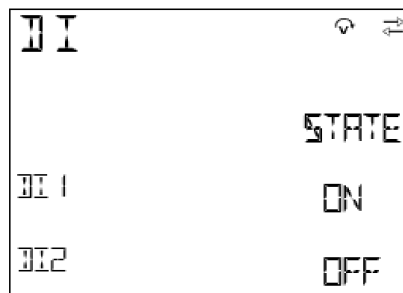
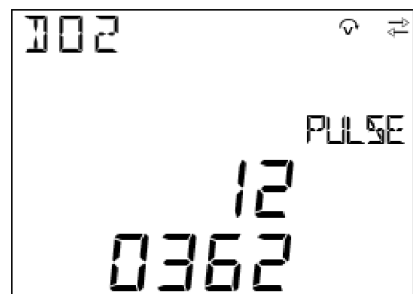
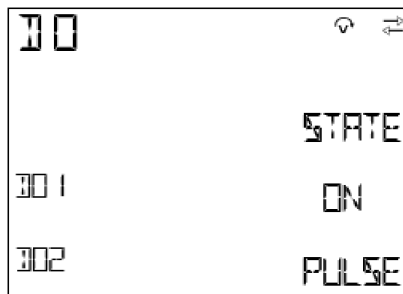

The state classifications include:

State	Description
ON	DO is on
OFF	DO is off
PULSE	Pulse output

### 8.5. Notifications (NOTF)

NOTF includes the following items:

Menu	Description
ALARM	Alarm list, user settable and related to specific parameters, threshold, etc
WARN	Warnings list, related to installation conditions and device settings.
ERROR	Errors list, related to the device and to its self-diagnostics.

#### Alarms (ALM)

ALARM is generated based on the Alarm configured by the user. When the conditions meet the alarm parameters, the ALARM notification will be generated and Icon  will be displayed.

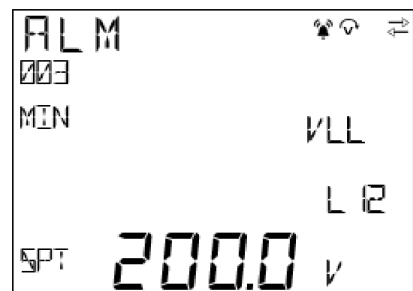
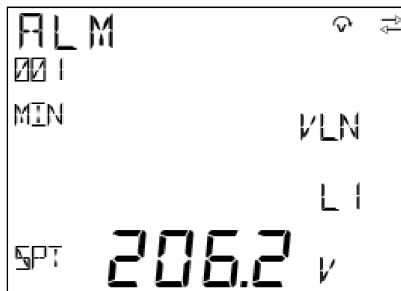
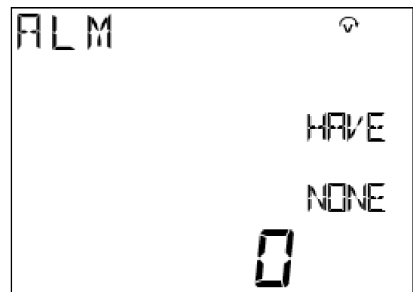
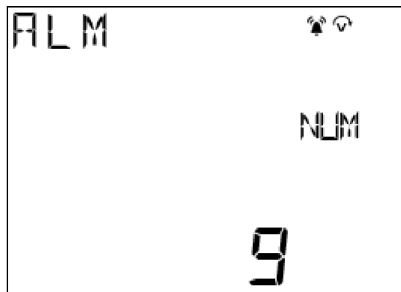

ALARM comprises alarm count and specific alarm message. The alarm message consists of alarm number, variable name, type, phase and threshold.

 > READ > NOTF > ALM





**Warnings (WARN)**

WARN is generated when the device detects the operating conditions. When there is a WARN notification, Icon  will be displayed; and when the user checks all warn messages, Icon  will disappear.

WARN comprises warn count and specific warn message.

 > READ > NOTF > WARN

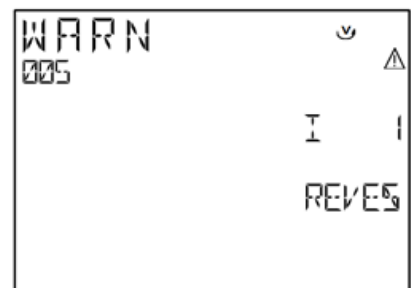
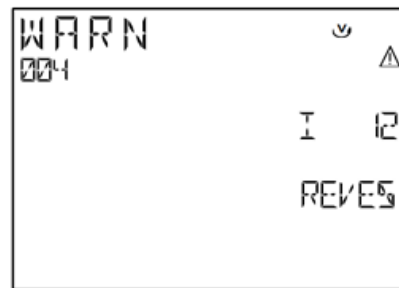
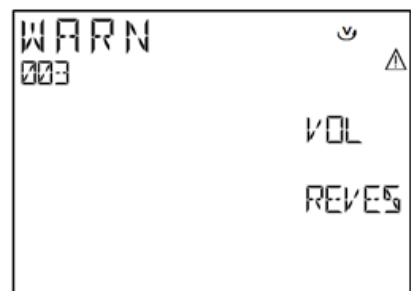
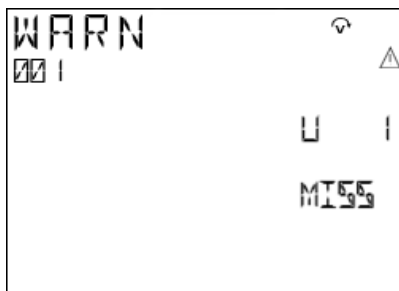
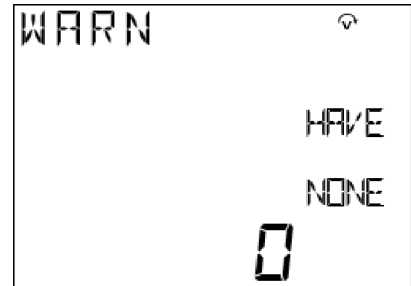
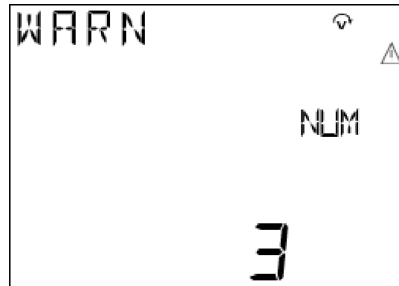

Warning	Definition
VOL REVES	Voltage Reverse
U1 MISS	Voltage 1 Missing
U2 MISS	Voltage 2 Missing
U3 MISS	Voltage 3 Missing
I1 MISS	Current 1 Missing
I2 MISS	Current 2 Missing
I3 MISS	Current 3 Missing
I1 REVES	Current 1 Reverse
I2 REVES	Current 2 Reverse
I3 REVES	Current 3 Reverse
I12 REVES	Current 1 with 2 Reverse
I23 REVES	Current 2 with 3 Reverse
I31 REVES	Current 3 with 1 Reverse

**Errors (ERR)**

ERROR is generated when the device detects operating conditions. When there is an ERROR notification, Icon  will be displayed and it will not disappear until the error is solved.

ERROR comprises error count and specific error message.

 > READ > NOTF > ERR

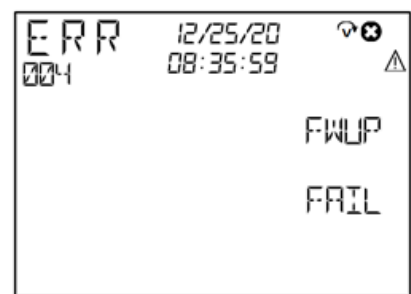
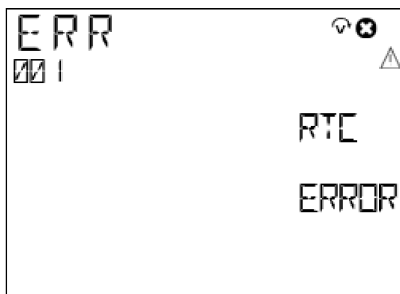
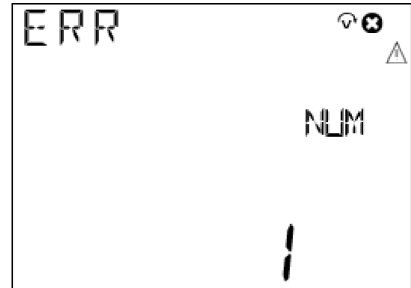
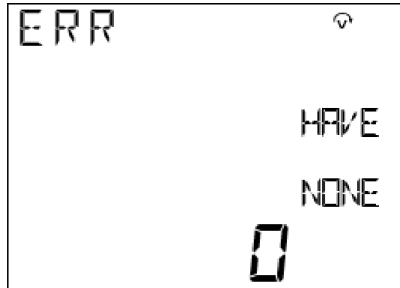

Error	Definition
UNCONFIG	EEPROM Missing
FWUP FAIL	Firmware update Failure (only M1M with communication)
REPROVED	Product not Approved

**8.6. Timers (TIME)**

TIME includes count-up timers reading.

Count-up timer starts counting when the device is first started off from the user.

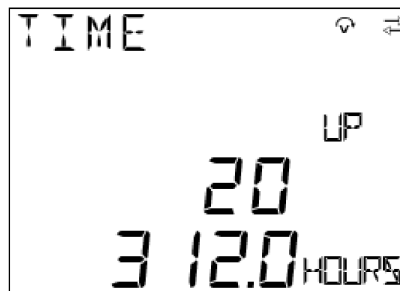



A series of horizontal dotted lines spanning the width of the page, providing a template for writing or drawing.



---

**ABB LV Installation Materials Co. Ltd. Beijing**

Electrification Business Area

No. 17 Kangding Street , Beijing

Economic-Technological Development Area 100176

[new.abb.com/low-voltage](http://new.abb.com/low-voltage)

