



**EPSITRON<sup>®</sup>**  
**Electronic Circuit Breaker**  
**787-1664(/xxxx-xxxx)**  
**24 VDC, 4 × 2 ... 10 A**

Version 1.1.0

© 2014 by WAGO Kontakttechnik GmbH & Co. KG  
All rights reserved.

### **WAGO Kontakttechnik GmbH & Co. KG**

Hansastraße 27  
D-32423 Minden

Phone: +49 (0) 571/8 87 – 0  
Fax: +49 (0) 571/8 87 – 1 69

E-Mail: [info@wago.com](mailto:info@wago.com)

Web: <http://www.wago.com>

### **Technical Support**

Phone: +49 (0) 571/8 87 – 5 55  
Fax: +49 (0) 571/8 87 – 85 55

E-Mail: [support@wago.com](mailto:support@wago.com)

Every conceivable measure has been taken to ensure the accuracy and completeness of this documentation. However, as errors can never be fully excluded, we always appreciate any information or suggestions for improving the documentation.

E-Mail: [documentation@wago.com](mailto:documentation@wago.com)

We wish to point out that the software and hardware terms as well as the trademarks of companies used and/or mentioned in the present manual are generally protected by trademark or patent.

# Table of Contents

<b>1</b>	<b>Notes about this Documentation.....</b>	<b>5</b>
1.1	Validity of this Documentation.....	5
1.2	Copyright.....	5
1.3	Symbols.....	6
1.4	Number Notation.....	8
1.5	Font Conventions.....	8
<b>2</b>	<b>Important Notes .....</b>	<b>9</b>
2.1	Legal Bases .....	9
2.1.1	Subject to Changes .....	9
2.1.2	Personnel Qualifications.....	9
2.1.3	Use of the 787 Series in Compliance with Underlying Provisions .....	9
2.1.4	Technical Condition of Specified Devices.....	10
2.2	Safety Advice (Precautions).....	11
<b>3</b>	<b>Device Description .....</b>	<b>13</b>
3.1	View .....	14
3.2	Connectors.....	15
3.2.1	Power supply .....	15
3.2.2	Fuse-Protected Outputs .....	16
3.2.3	Control and Signaling Contacts.....	16
3.3	Display Elements .....	17
3.4	Operating Elements .....	18
3.4.1	Buttons.....	18
3.4.2	Rotary Switch .....	19
3.5	Technical Data .....	20
3.5.1	Device Data .....	20
3.5.2	Technical Data for "Input" .....	21
3.5.3	Technical Data for "Output" .....	22
3.5.4	Technical Data for "Ambient conditions" .....	23
3.5.5	Technical Data for "Signaling" .....	23
3.6	Approvals .....	24
3.7	Standards and Guidelines .....	25
<b>4</b>	<b>Mounting.....</b>	<b>26</b>
4.1	Mounting .....	26
4.2	Mounting the Device on the DIN 35 Rail .....	26
4.3	Removing the Device from the DIN 35 Rail .....	27
<b>5</b>	<b>Connect Devices .....</b>	<b>28</b>
5.1	Connection Example .....	28
<b>6</b>	<b>Function Description .....</b>	<b>29</b>
6.1	Undervoltage and Overvoltage Detection.....	29
6.2	Trip Curves.....	29
6.2.1	Trip Curve for the 10 A Circuit Breaker 787-1664.....	29
6.2.2	Trip Curve for the 6 A Circuit Breaker 787-1664/0106-0000 .....	30
6.2.3	Trip Curve for the 6 A Circuit Breaker with Active Current Limitation 787-1664/0006-1000 .....	30

6.2.3.1	Response of the Electronic Circuit Breaker with Active Current Limitation .....	31
6.2.3.1.1	Response 1: Over-current present that is greater than <i>Threshold 3</i> .....	32
6.2.3.1.2	Response 2: Over-current present that is greater than <i>Threshold 1</i> , but less than <i>Threshold 2</i> .....	32
6.2.3.1.3	Response 3: Over-current present that is greater than the nominal current, but less than <i>Threshold 1</i> .....	32
6.2.3.2	Selective immediate deactivation .....	32
6.3	Activating Capacitive Loads .....	33
6.3.1	Reference Values for 787-1664 and 787-1664/0106-0000 .....	33
6.3.2	Reference Values for 787-1664/0006-1000 .....	33
6.4	Operating Statuses, Signaling, Reactions.....	34
6.5	ON Delay for Specific Channels.....	36
6.6	Control Input S1 .....	37
6.6.1	Re-activating Tripped Channels .....	37
6.6.2	Specific Activation and De-activation of Non-Tripped Output Channels .....	38
6.7	Signal Output S2 .....	42
6.8	Functioning of Communication between Control Input S1 and Signal Output S2 .....	44
6.9	Signal Output S3 .....	45
	<b>List of Figures .....</b>	<b>46</b>
	<b>List of Tables.....</b>	<b>47</b>

# 1 Notes about this Documentation

## Note



### Keep this documentation!

The operating instructions are part of the product and shall be kept for the entire lifetime of the device. They shall be transferred to each subsequent owner or user of the device. Care must also be taken to ensure that any supplement to these instructions are included, if applicable.

## 1.1 Validity of this Documentation

This documentation applies to the electronic circuit breaker 787-1664 and the versions listed in the following table.

Table 1: Versions

Item No./Version	Description
787-1664/0106-0000	Electronic Circuit Breaker 24 V DC, 4×6 A
787-1664/0006-1000	Electronic Circuit Breaker 24 V DC, 4×6 A, with Active Current Limitation

## 1.2 Copyright

This Manual, including all figures and illustrations, is copyright-protected. Any further use of this Manual by third parties that violate pertinent copyright provisions is prohibited. Reproduction, translation, electronic and phototechnical filing/archiving (e.g., photocopying) as well as any amendments require the written consent of WAGO Kontakttechnik GmbH & Co. KG, Minden, Germany. Non-observance will involve the right to assert damage claims.

## 1.3 Symbols

 **DANGER****Personal Injury!**

Indicates a high-risk, imminently hazardous situation which, if not avoided, will result in death or serious injury.

 **DANGER****Personal Injury Caused by Electric Current!**

Indicates a high-risk, imminently hazardous situation which, if not avoided, will result in death or serious injury.

 **WARNING****Personal Injury!**

Indicates a moderate-risk, potentially hazardous situation which, if not avoided, could result in death or serious injury.

 **CAUTION****Personal Injury!**

Indicates a low-risk, potentially hazardous situation which, if not avoided, may result in minor or moderate injury.

**NOTICE****Damage to Property!**

Indicates a potentially hazardous situation which, if not avoided, may result in damage to property.

**NOTICE****Damage to Property Caused by Electrostatic Discharge (ESD)!**

Indicates a potentially hazardous situation which, if not avoided, may result in damage to property.

**Note****Important Note!**

Indicates a potential malfunction which, if not avoided, however, will not result in damage to property.



## *Information*

**Additional Information:**

Refers to additional information which is not an integral part of this documentation (e.g., the Internet).

---

## 1.4 Number Notation

Table 2: Number notation

Number code	Example	Note
Decimal	100	Normal notation
Hexadecimal	0x64	C notation
Binary	'100' '0110.0100'	In quotation marks, nibble separated with dots (.)

## 1.5 Font Conventions

Table 3: Font conventions

Font type	Indicates
<i>italic</i>	Names of paths and data files are marked in italic-type. e.g.: <i>C:\Programme\WAGO-I/O-CHECK</i>
<b>Menu</b>	Menu items are marked in bold letters. e.g.: <b>Save</b>
>	A greater-than sign between two names means the selection of a menu item from a menu. e.g.: <b>File &gt; New</b>
<b>Input</b>	Designation of input or optional fields are marked in bold letters, e.g.: <b>Start of measurement range</b>
“Value”	Input or selective values are marked in inverted commas. e.g.: Enter the value “4 mA” under <b>Start of measurement range</b> .
<b>[Button]</b>	Pushbuttons in dialog boxes are marked with bold letters in square brackets. e.g.: <b>[Input]</b>
<b>[Key]</b>	Keys are marked with bold letters in square brackets. e.g.: <b>[F5]</b>



## 2 Important Notes

This section includes an overall summary of the most important safety requirements and notes that are mentioned in each individual section. To protect your health and prevent damage to devices as well, it is imperative to read and carefully follow the safety guidelines.

### 2.1 Legal Bases

#### 2.1.1 Subject to Changes

WAGO Kontakttechnik GmbH & Co. KG reserves the right to provide for any alterations or modifications that serve to increase the efficiency of technical progress. WAGO Kontakttechnik GmbH & Co. KG owns all rights arising from the granting of patents or from the legal protection of utility patents. Third-party products are always mentioned without any reference to patent rights. Thus, the existence of such rights cannot be excluded.

#### 2.1.2 Personnel Qualifications

All sequences implemented on 787 Series devices may only be carried out by electrical specialists with sufficient knowledge in automation. The specialists must be familiar with the current norms and guidelines for the devices and automated environments.

#### 2.1.3 Use of the 787 Series in Compliance with Underlying Provisions

The *EPSITRON*® 787 Series power supply system provides direct current to electric or electronic devices, such as industrial control systems or display, communication and measuring devices.

The devices have been developed for use in an environment that meets the IP20 protection class criteria. Protection against finger injury and solid impurities up to 12.5 mm diameter is assured; protection against water damage is not ensured. Unless otherwise specified, operation of the components in wet and dusty environments is prohibited.

The devices are designed for installation in an enclosure. Under no circumstances may they be used in control systems for planes or nuclear facilities, as any malfunction in these applications could result in severe injuries or risk of death.

## 2.1.4 Technical Condition of Specified Devices

The components to be supplied Ex Works, are equipped with hardware and software configurations, which meet the individual application requirements. WAGO Kontakttechnik GmbH & Co. KG will be exempted from any liability in case of changes in hardware or software as well as to non-compliant usage of components.

Please send your request for modified and new hardware or software configurations directly to WAGO Kontakttechnik GmbH & Co. KG.

## 2.2 Safety Advice (Precautions)

For installing and operating purposes of the relevant device to your system the following safety precautions shall be observed:

---

 **DANGER**  
**Do not work on components while energized!**  
All power sources to the device shall be switched off prior to performing any installation, repair or maintenance work.

---

 **DANGER**  
**Installation only in appropriate housings, cabinets or in electrical operation rooms!**  
Always install devices of the 787 Series in enclosures, cabinets or electrical equipment rooms which can be closed and locked. Ensure that access to this equipment/these rooms is possible only by authorized specialists with the appropriate key or tools.

---

 **DANGER**  
**Do not use these devices in control systems for planes, trains or nuclear facilities!**  
Never use these devices in control systems for planes, trains or nuclear facilities, as any malfunction in these applications can result in severe injuries or risk of death!

---

**NOTICE**  
**Switch off power supply to defective device!**  
Switch off power supply to the device immediately if the device malfunctions or is damaged! Control systems connected to the device may also be damaged!  
Return the defective device directly to WAGO.

---

**NOTICE**  
**Do not plug in or disconnect the female connector while a load is applied!**  
Only plug in or disconnect the female connectors when the device is not live!  
Failure to observe this can result in damage to the contacts due to arcing!

---

**NOTICE**  
**Plug the female connectors all the way into the male connectors!**  
Always plug the female connectors all the way in to the male connectors. This ensures proper contact at all times.

---

**NOTICE****Attach the free ends of the conductors using a strain relief device!**

Provide appropriate strain relief means to attach and cap any free ends of the conductors. Female connectors can be pulled out of the male connectors by high vibration levels or shock impacts.

**NOTICE****Protect the components against materials having seeping and insulating properties!**

The components are not resistant to materials having seeping and insulating properties such as: aerosols, silicones and triglycerides (found in some hand creams). If you cannot exclude that such materials will appear in the component environment, then install the components in an enclosure being resistant to the above-mentioned materials. Clean tools and materials are imperative for handling devices/modules.

**NOTICE****Cleaning only with permitted materials!**

Clean soiled contacts using oil-free compressed air or with ethyl alcohol and leather cloths.

**NOTICE****Do not use any contact spray!**

Do not use any contact spray. The spray may impair contact area functionality in connection with contamination.

**NOTICE****Do not reverse the polarity of connection lines!**

Avoid reverse polarity of data and power supply lines, as this may damage the devices involved.

**NOTICE****Avoid electrostatic discharge!**

The devices are equipped with electronic components that you may destroy by electrostatic discharge when you touch. Pay attention while handling the devices to good grounding of the environment (persons, job and packing).

### 3 Device Description

The 787-1664 electronic circuit breaker reliably protects up to 4 load circuits against short circuiting and overloading. The 24 VDC input voltage is distributed among 4 output channels, each of which can be provided with separate fuse protection.

Table 4: Fuse Protection of Output Channels

Variant	Fuse protection for each output channel (can be set)
787-1664	2 A, 3 A, 4 A, 6 A, 8 A, 10 A
787-1664/0106-0000	1 A, 2 A, 3 A, 4 A, 5 A, 6 A
787-1664/0006-1000	0,5 A, 1 A, 2 A, 3 A, 4 A, 6 A (with active current limitation)

The electronics can accommodate brief current peaks.

There are 4 rotary switches on the device which can be used to set the nominal current for each of the individual output channels.

The current status of the output channel is indicated by a multi-colored LED.

In the event of a short circuit or overloading, the individual output channel is de-energized after a defined trip time.

#### Note



#### Wait for temperature to return to normal!

If an output channel has been de-activated due to short-circuiting or overloading, wait until the temperature returns to its normal range (cooling period) before re-activating the channel.

The device contains control and signaling contacts, which can be used for reading out information relevant to operation. These contacts are also used to activate and de-activate specific output channels individually. This device is equipped with

- one digital control input and
- two digital signal outputs.

### 3.1 View

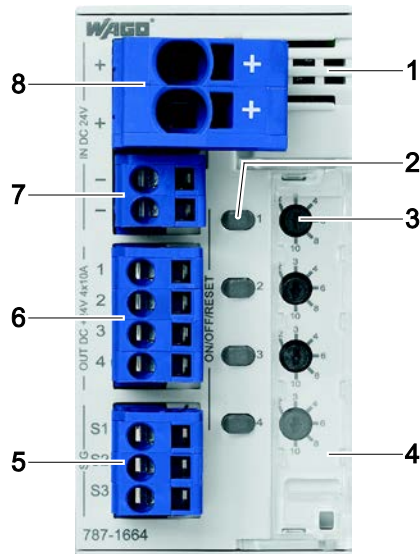

Figure 1: View of device

Table 5: Key for "Device view" figure

No.	Designation	Reference
1	Marking field *)	
2	Switch	"Device Description" > "Operating Elements" > "Buttons"
3	Rotary switch	"Device Description" > "Operating Elements" > "Rotary Switches"
4	Cover, sealable **)	
5	CAGE CLAMP® connections Control input S1 and Signaling outputs S2 and S3	"Function Description" > "Control Input S1"/ "Signaling Output S2"/ "Signaling Output S3"
6	CAGE CLAMP® connections for fuse-protected output channels	"Device Description" > "Connections" > "Fuse-Protected Output Channels"
7	CAGE CLAMP® connections for 0 V reference potential (for internal supply only)	"Device Description" > "Connections" > "Power Supply"
8	CAGE CLAMP® connections for 24 V input voltage	

\*) can be marked using TOPJOB® S marker strips (Item No. 2009-110) or WMB Multi marking system

\*\*\*) can also be marked using TOPJOB® S marker strips (Item No. 2009-110)

## 3.2 Connectors

### NOTICE

**Do not plug in or disconnect the female connector while a load is applied!**  
Only plug in or disconnect the female connectors when the device is not live!  
Failure to observe this can result in damage to the contacts due to arcing!

### NOTICE

**Plug the female connectors all the way into the male connectors!**  
Always plug the female connectors all the way in to the male connectors. This ensures proper contact at all times.

### NOTICE

**Attach the free ends of the conductors using a strain relief device!**  
Provide appropriate strain relief means to attach and cap any free ends of the conductors. Female connectors can be pulled out of the male connectors by high vibration levels or shock impacts.

### 3.2.1 Power supply

Table 6: Power supply connections

	No.	Designation	Function
	1	+	24 V input voltage
	2	+	24 V input voltage

Figure 2: 24 V input

Table 7: Power supply connections

	No.	Designation	Function
	1	-	Reference potential 0 V
	2	-	Reference potential 0 V

Figure 3: 0 V input

**NOTICE****Total current exceeds 40 A!**

Distribute the current to input terminals "IN1" and "IN2" when the total current should exceed 40°A, as otherwise the plug-in connectors will become overheated and can be damaged or destroyed.

**3.2.2 Fuse-Protected Outputs**

Table 8: Connections – Fuse-protected outputs

	No.	Designation	Function
 <p data-bbox="347 817 614 873">Figure 4: Fuse-protected outputs Ch1 ... Ch4</p>	1 ... 4	Ch1 ... Ch4	Fuse-protected outputs Ch1 ... Ch4

**3.2.3 Control and Signaling Contacts**

Table 9: Connections – Control and signaling contacts

	No.	Designation	Function
 <p data-bbox="347 1323 582 1379">Figure 5: Control and signaling contacts</p>	1	S1	Control Input S1
	2	S2	Signal Output S2
	3	S3	Signal Output S3



### 3.3 Display Elements

A multi-colored LED, integrated in a button, is assigned to each output channel. This LED indicates the current operating status of the output channel.

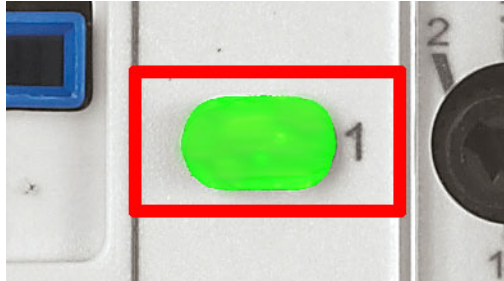

Figure 6: Indicators

Table 10: Legend for "Indicators" figure

LED	Button color	Explanation
1 ... 4	Green	Output channel activated
	Red	Output channel deactivated
	Red, flashing	Wait for temperature to return to normal (cooling period)

#### Note



#### Further signaling possible!

Other statuses can also be indicated if an error occurs. For information about this, refer to the "Operating Statuses, Signaling, Reactions" table given in this manual.

## 3.4 Operating Elements

### 3.4.1 Buttons

A button is assigned to each output channel. Depending on the operating mode the button can have two different functions:

- During operation, the channel can be activated and de-activated.
- If an error is present, the channel can be reset.

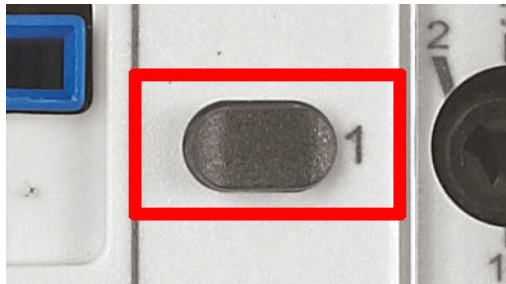

Figure 7: Buttons

### 3.4.2 Rotary Switch

A rotary switch, which can be used to set the output currents for the individual outputs, is assigned to each output channel. The following settings are possible:

Table 11: Rotary Switch Settings

Variant	Setting					
787-1664	2 A	3 A	4 A	6 A	8 A	10 A
787-1664/0106-0000	1 A	2 A	3 A	4 A	5 A	6 A
787-1664/0006-1000	0.5 A	1 A	2 A	3 A	4 A	6 A

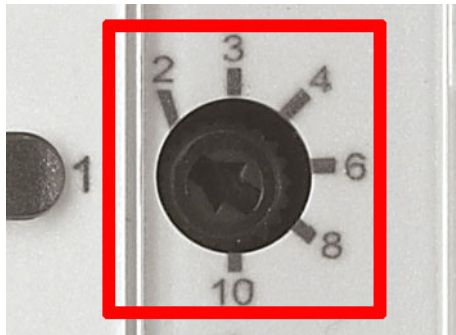

Figure 8: Rotary Switch

## Note



### Observe trip curve!

Observe the trip curve given in the Section "Function Description" when setting the individual output channels.

## 3.5 Technical Data

### 3.5.1 Device Data

Table 12: Device data

Width	45 mm
Height	90 mm
Depth (from upper edge of DIN 35 rail)	115.5 mm
Weight	170 g

### 3.5.2 Technical Data for "Input"

Table 13: Technical data - "Input"

Nominal input voltage	24 VDC
Input voltage range	18 ... 30 VDC
Maximum residual ripple/ ripple for the input voltage	3 % with resistive load
Required input voltage at which the output channels are activated (activation threshold)	20 V
Input voltage at which the output channels are de-activated (trip threshold)	18 V
Maximum continuous current for the device	<b>787-1664:</b> 40 A <b>787-1664/0106-0000,</b> <b>787-1664/0006-1000:</b> 24 A
Maximum continuous current per I/O module pole	40 A
Overvoltage protection	Suppressor diodes (33 V)
Zero-signal current for open-circuit operation at 24 V	<b>787-1664,</b> <b>787-1664/0106-0000:</b> 35 mA <b>787-1664/0006-1000:</b> 32 mA
Power dissipation for open-circuit operation at 24 V	<b>787-1664,</b> <b>787-1664/0106-0000:</b> 0.84 W <b>787-1664/0006-1000:</b> 0.77 W
Input modules	<i>WAGO-MULTI CONNECTION SYSTEM (MCS), 721 Series</i> Connection: 0.08 mm <sup>2</sup> ... 2.5 mm <sup>2</sup> (maximum 1.5 mm <sup>2</sup> with insulated ferrule)  <i>WAGO-MULTI CONNECTION SYSTEM (MCS), 831 Series</i> Connection: 0.5 mm <sup>2</sup> ... 10 mm <sup>2</sup> (maximum 6 mm <sup>2</sup> with insulated ferrule)

### 3.5.3 Technical Data for "Output"

Table 14: Technical data - "Output"

Nominal output voltage	4 x 24 VDC
Output nominal current (adjustable)	<p><b>787-1664:</b> 2 A, 3 A, 4 A, 6 A, 8 A, 10 A</p> <p><b>787-1664/0106-0000:</b> 1 A, 2 A, 3 A, 4 A, 5 A, 6 A</p> <p><b>787-1664/0006-1000:</b> 0.5 A, 1 A, 2 A, 3 A, 4 A, 6 A</p>
Voltage drop between input and output	<p><b>787-1664:</b> 200 mV with maximum output current</p> <p><b>787-1664/0106-0000:</b> 120 mV with maximum output current</p> <p><b>787-1664/0006-1000:</b> 145 mV with maximum output current</p>
Device initialization time	250 ms
Waiting period after an output channel has been de-activated (cooling time)	<p><b>787-1664,</b></p> <p><b>787-1664/0106-0000:</b> 500 ms (short circuit), 20 s (overload)</p> <p><b>787-1664/0006-1000:</b> 500 ms (short circuit), 10 s (overload)</p>
Total power dissipation for output current 4 x 10 A	<p><b>787-1664:</b> 10 W with maximum output current</p> <p><b>787-1664/0106-0000:</b> 4.2 W with maximum output current</p> <p><b>787-1664/0006-1000:</b> 4.3 W with maximum output current</p>
Efficiency	99 %
Maximum load capacity per output channel	<p><b>787-1664,</b></p> <p><b>787-1664/0106-0000:</b> greater than 50 ... 620 mF</p> <p><b>787-1664/0006-1000:</b> greater than 65 ... 620 mF</p>
Integrated fusing per output channel	15 A, slow
ON delay	Based on load: minimum 50 ms, maximum 5 s
Recovery stability	maximum 35 V
Parallel connection of output channels	prohibited
Series connection of output channels	prohibited
Output terminals	WAGO-MULTI CONNECTION SYSTEM (MCS), 721 Series Connection: 0.08 mm <sup>2</sup> ... 2.5 mm <sup>2</sup> (maximum 1.5 mm <sup>2</sup> with insulated ferrule)

### 3.5.4 Technical Data for "Ambient conditions"

Table 15: Technical data - "Ambient conditions"

Ambient temperature range	-25 °C ... +70 °C
Derating	<p><b>787-1664:</b> Maximum 10 A per output channel Total output current (all output channels) 40 A ≥ 40 °C, 35 A ≥ 50 °C, 25 A ≥ 60 °C 20 A = 70 °C.</p> <p><b>787-1664/0106-0000, 787-1664/0006-1000:</b> no derating</p>
Requisite minimum spacing (top/bottom)	40 mm
Requisite minimum spacing (lateral)	0 mm

### 3.5.5 Technical Data for "Signaling"

Table 16: Technical data - "Signaling"

LED	green/red/orange (per output channel)
Control Input S1	<p>non electrically isolated 24 VDC input (relative to the module 0 V input) Voltage level "active high": minimum 15 V, maximum 30 V Voltage level "active low": minimum 0 V, maximum 5 V Jitter for pulse pattern: ±5 % or ±5 ms; with the higher value applying. Waiting period after pulse sequence (low level): minimum 200 ms</p>
Signal Output S2	24 VDC, active high, short-circuit proof maximum current carrying capacity: 25 mA
Signal Output S3	24 VDC, active high, short-circuit proof maximum current carrying capacity: 25 mA
Control and Signaling Terminals (S1, S2, S3)	<p><i>WAGO-MULTI CONNECTION SYSTEM (MCS), 721 Series</i> Connection: 0.08 mm<sup>2</sup> ... 2.5 mm<sup>2</sup> (maximum 1.5 mm<sup>2</sup> with insulated ferrule)</p>

## 3.6 Approvals

The following approvals have been granted for the standard version of the electronic circuit breaker 787-1664 and version 787-1664/0106-0000:

 Conformity Marking

 cUL<sub>US</sub> UL508

 UR UL2367

 GL (Germanischer Lloyd) Cat. C (EMC 2)

The following approvals have been granted for the version 787-1664/0006-1000 of the electronic circuit breaker 787-1664:

 Conformity Marking

 GL (Germanischer Lloyd) Cat. C (EMC 2)

The following approvals are pending for the version 787-1664/0006-1000 of the electronic circuit breaker 787-1664:

 cUL<sub>US</sub> UL508

 UR UL2367



### 3.7 Standards and Guidelines

The 787-1664 electronic circuit breaker is in compliance with the following standards and guidelines:

EC Low Voltage directive (LVD)	2006/95/EC
EC EMC Directive	2004/108/EC
Information technology equipment – Safety – Part 1: General requirements	DIN EN 60950-1:2006 + A11:2009 + A1:2010 + A12:2012
Electromagnetic compatibility (EMC) – Part 6-2: Generic standards – Immunity for industrial environments	DIN EN 61000-6-2:2005
Electromagnetic compatibility (EMC) – Part 6-3: Generic standards – Emission standard for residential, commercial and light-industrial environments	DIN EN 61000-6-3:2007 + A1:2011

## 4 Mounting

### 4.1 Mounting

The device is designed for mounting on a DIN 35 rail.

### 4.2 Mounting the Device on the DIN 35 Rail

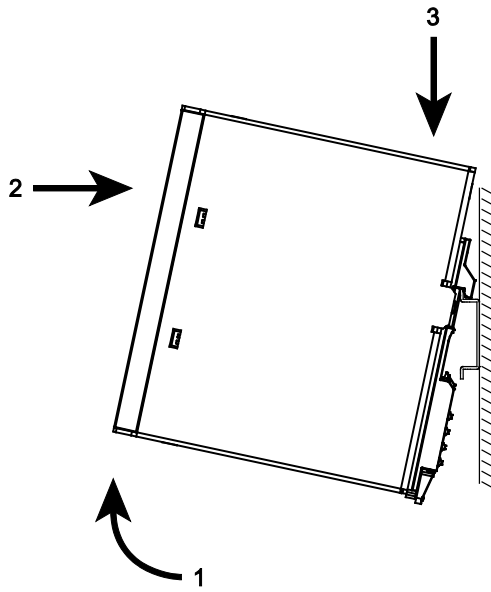

Figure 9: Mounting the device on the DIN 35 rail

1. Tilt the device slightly.
2. Place the device with its DIN rail guide on the top edge of the DIN rail.
3. Slide the device all the way down.

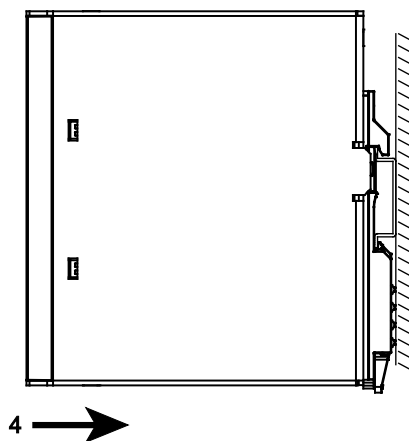

Figure 10: Mounting the device on the DIN 35 rail

4. Press it down against the bottom fastener until you hear it lock into place.
5. Lightly shake the device to ensure that it is correctly locked into place.

### 4.3 Removing the Device from the DIN 35 Rail

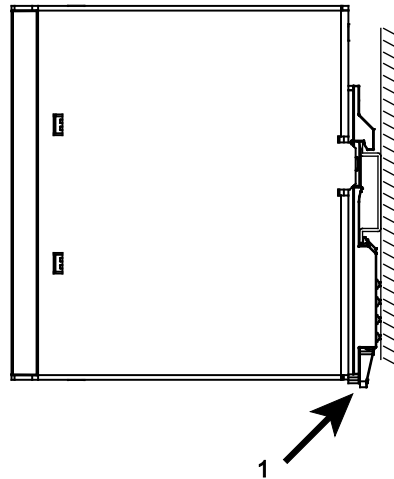

Figure 11: Removing the device from the DIN 35 rail

1. Use a screwdriver to press down on the locking tab.

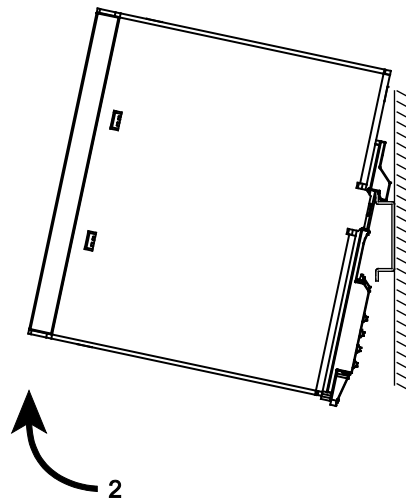

Figure 12: Removing the device from the DIN 35 rail

2. Pull the device out at the bottom edge of the DIN 35 rail.

## 5 Connect Devices

### 5.1 Connection Example

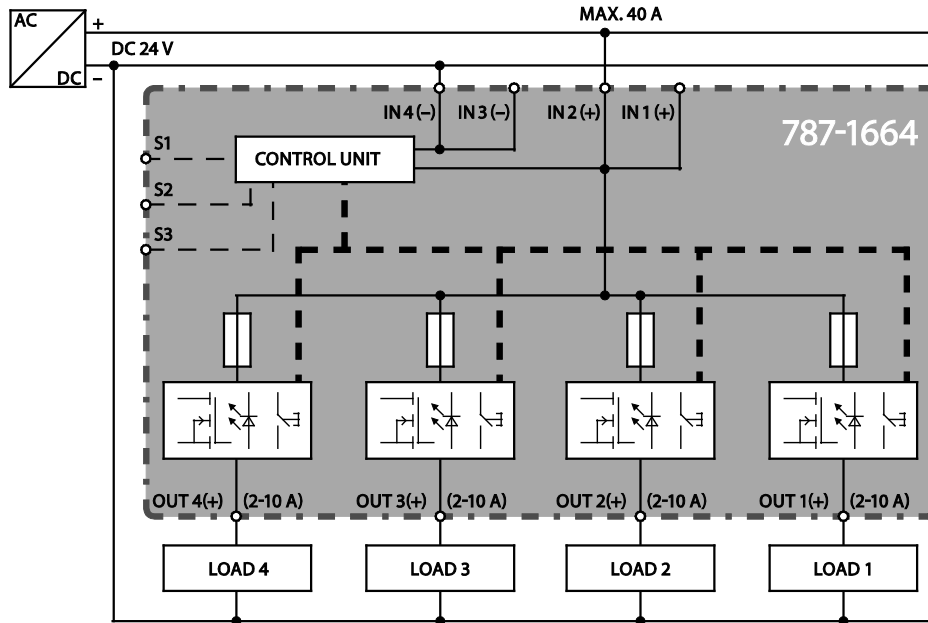

Figure 13: Connection example

## 6 Function Description

### 6.1 Undervoltage and Overvoltage Detection

This device operates in a voltage range between 18 ... 30 VDC.

### 6.2 Trip Curves

#### 6.2.1 Trip Curve for the 10 A Circuit Breaker 787-1664

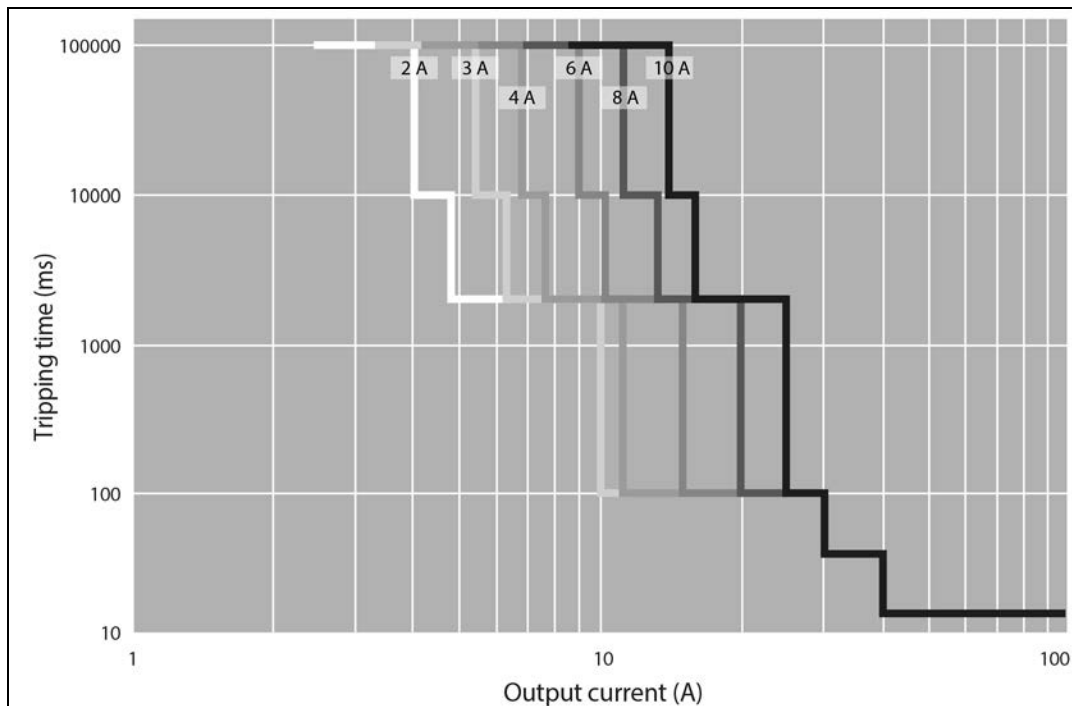

Figure 14: Trip Curve for the 10 A Circuit Breaker 787-1664

### 6.2.2 Trip Curve for the 6 A Circuit Breaker 787-1664/0106-0000

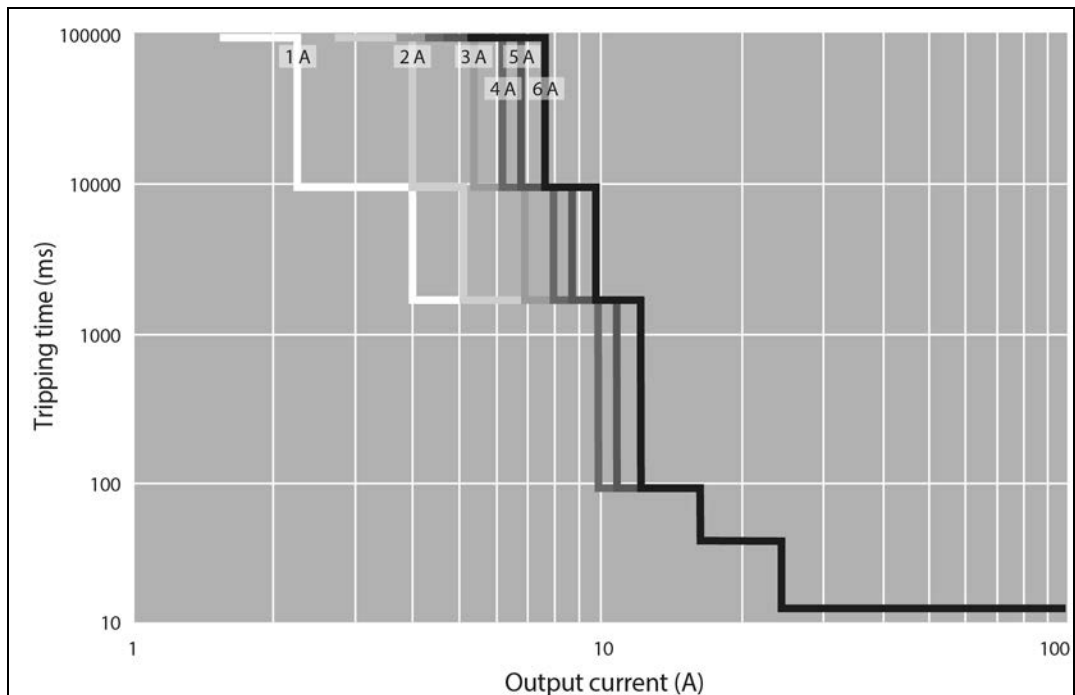

Figure 15: Trip Curve for the 6 A Circuit Breaker 787-1664/0106-0000

### 6.2.3 Trip Curve for the 6 A Circuit Breaker with Active Current Limitation 787-1664/0006-1000

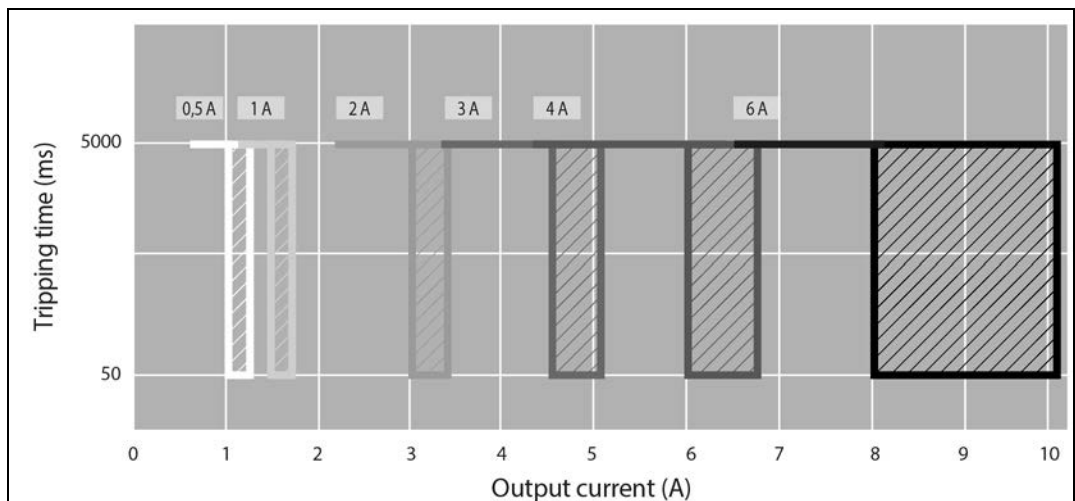

Figure 16: Trip Curve for the 6 A Circuit Breaker with Active Current Limitation 787-1664/0006-1000

### 6.2.3.1 Response of the Electronic Circuit Breaker with Active Current Limitation

Nominal current	Shutdown takes place		
	after 5 seconds, with an over-current greater than	within 50 milliseconds ... 5 seconds, with an over-current between	
	( <i>Threshold 1</i> )	( <i>Threshold 2</i> )	( <i>Threshold 3</i> )
0.5 A	0.75 A	1.00 A	1.20 A
1 A	1.20 A	1.50 A	1.70 A
2 A	2.20 A	3.00 A	3.40 A
3 A	3.30 A	4.50 A	5.10 A
4 A	4.40 A	6.00 A	6.80 A
6 A	6.60 A	8.00 A	10.2 A

The function is activated when

- an over-current measured at an output is greater than the corresponding threshold for the set nominal current (*Threshold 1*).
- the measured over-current is present for more than 0.1 ms.

The activated circuit breaker can respond in one of three ways:

1. An over-current is present that is greater than *Threshold 3*
2. An over-current is present that is greater than *Threshold 1*, but less than *Threshold 2*
3. An over-current is present that is greater than the nominal current, but less than *Threshold 1*

**6.2.3.1.1 Response 1: Over-current present that is greater than *Threshold 3***

If an over-current is present that is greater than *Threshold 3*, the current will be limited to a value situated between *Threshold 2* and *Threshold 3*. This limitation is effective for at least 50 ms and functions as a variable series resistor. The output voltage is less than the input voltage.

If the over-current does not decrease, the output concerned will be deactivated within a period of 50 ms ... 5 s.

**6.2.3.1.2 Response 2: Over-current present that is greater than *Threshold 1*, but less than *Threshold 2***

If an over-current is present that is greater than *Threshold 1*, but less than *Threshold 2*, the output will be deactivated after 5 s.

**6.2.3.1.3 Response 3: Over-current present that is greater than the nominal current, but less than *Threshold 1***

If an over-current is present that is greater than the nominal current, but less than *Threshold 1*, the output is not deactivated. This over-current is report, however.

**6.2.3.2 Selective immediate deactivation**

If the output voltage from the power supply unit drops below 20 V, all outputs with current greater than the set nominal current are deactivated within 16 ms.



## 6.3 Activating Capacitive Loads

High capacitive loads can be applied using the electronic circuit breaker. The power supply unit providing power to the device must be capable of supplying a voltage of at least 18 VDC, even at the maximum required current. The required current can be set using the rotary switch.

The tables below gives some standard reference values determined in experiments with 24 VDC input voltage:

### 6.3.1 Reference Values for 787-1664 and 787-1664/0106-0000

Table 17: Standard reference values for 787-1664 and 787-1664/0106-0000

Line lengths (m) for feed and return lines	Making capacity (μF) with a wire cross section of 0.75 mm <sup>2</sup> *	Making capacity (μF) with a wire cross section of 1.5 mm <sup>2</sup> *	Making capacity (μF) with a wire cross section of 2.5 mm <sup>2</sup> *
0	48,000	48,000	48,000
2.5	61,500	70,000	63,300
5.0	83,300	50,000	73,300
10.0	130,000	53,300	73,300
20.0	> 620,000	81,300	63,300
40.0	> 620,000	222,800	91,500

\* Capacities determined with a base load of 10 A/6 A at the output channel.

### 6.3.2 Reference Values for 787-1664/0006-1000

Table 18: Standard reference values for 787-1664/0006-1000

Line lengths (m) for feed and return lines	Making capacity (μF) with a wire cross section of 0.75 mm <sup>2</sup> *	Making capacity (μF) with a wire cross section of 1.5 mm <sup>2</sup> *	Making capacity (μF) with a wire cross section of 2.5 mm <sup>2</sup> *
0	74,300	64,800	64,800
2.5	72,000	69,300	67,800
5.0	78,000	78,300	69,300
10.0	96,800	86,800	71,100
20.0	145,200	102,500	86,800
40.0	> 620,000	152,500	107,800

\* Capacities determined with a base load of 6 A at the output channel.

## 6.4 Operating Statuses, Signaling, Reactions

Table 19: Operating statuses, signaling, reactions

Status	Operating status	Channel	LED	Signal output S3 (common signal)	Button is pressed → Transition to ...	Control input S1 → Transition to ...
0	Device initialization. <sup>1</sup>	off	off	0 V	-	-
1	Output activated, function OK.	on	Green	24 V	Status 3	Status 3 (via bit pattern)
2	Output current greater than nominal current. <sup>2</sup>	on	Green flashing	24 V	Status 3	Status 3 (via bit pattern)
3	Output de-activated manually, or by control input S1. <sup>3</sup>	off	Red	24 V	Status 1	Status 1 (via bit pattern)
4	Output de-activated due to excessive current. Cooling (waiting) period is active. <sup>4</sup>	off	Red flashing	0 V	-	-
5	Output de-activated due to excessive current. Cooling (waiting) period is completed. <sup>5</sup>	off	Orange flashing	0 V	Status 3	Status 1 (using pulse longer than 0.5 s)
6	Device error: Defective fuse detected.	off	Red flashing, rapid	0 V	Status 6	-

<sup>1</sup> The outputs are re-activated based on the load applied as soon as device initialization is concluded.

<sup>2</sup> The output is de-activated automatically in accordance with the given trip curve. The device then switches to Status 4.

<sup>3</sup> The status is saved when the device is switched off.

<sup>4</sup> After a defined waiting period (cooling time), the output switches to Status 5. The remaining time of the waiting period is saved when the device is switched off. This time must first elapse when the device is switched on again. This feature protects the switching elements against any overloading.

<sup>5</sup> The output can be re-activated as follows:

- by pressing the associated button twice, or
- by applying a pulse at control input S1.

The device then switches to Status 1.



Abbildung 17: Operating Statuses, Signaling, Reactions

## 6.5 ON Delay for Specific Channels

The outputs are activated in a staggered manner in the order of their channel numbers as soon as a minimum input voltage is present. Outputs which have been de-activated manually, or by a reset signal, are skipped in this process.

The time at which the next output in the sequence is activated is based on the following conditions:

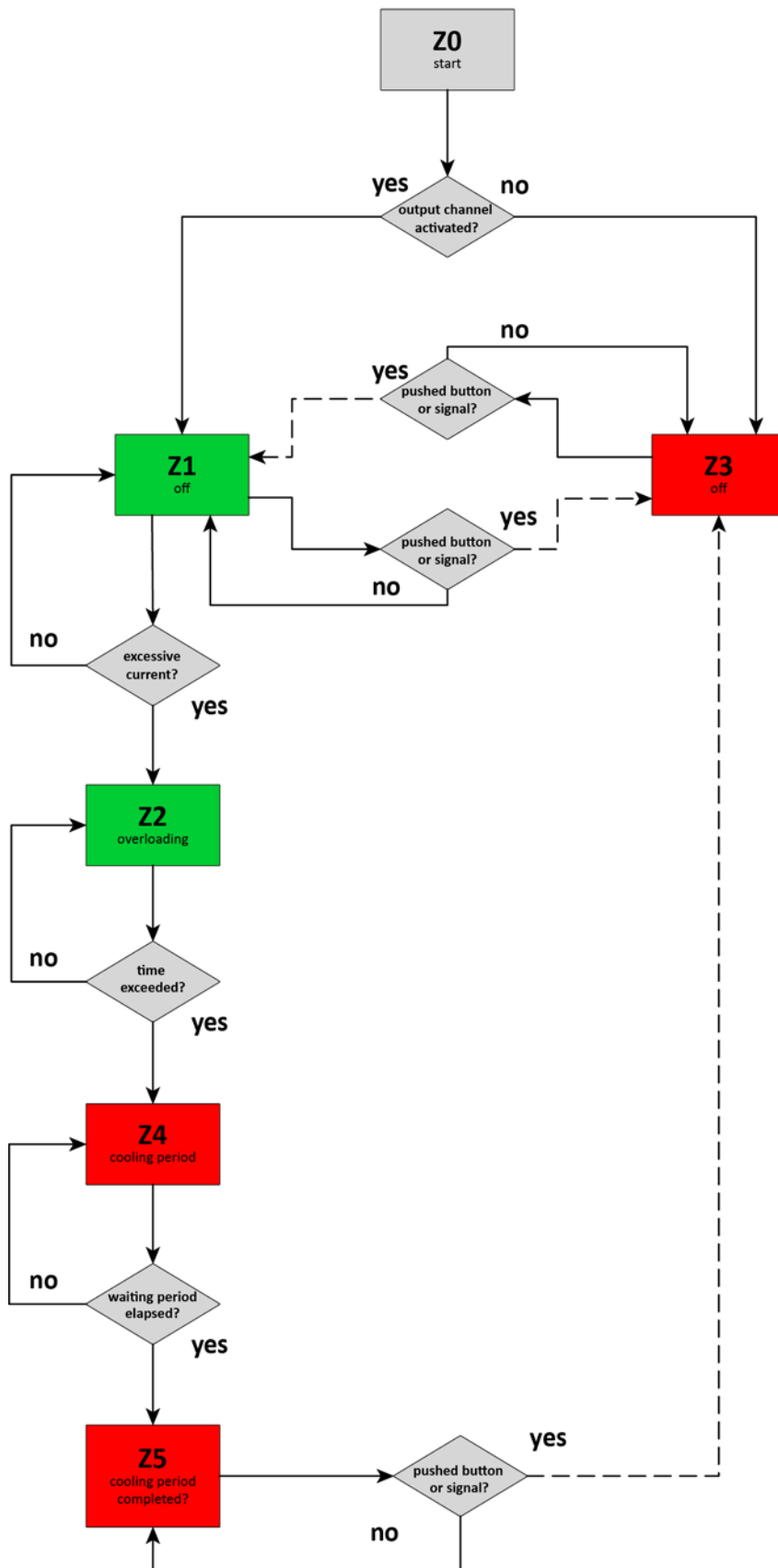
- At least 50 ms must elapse after activation of the previous output.
- The output current of the previously activated output must lie below the nominal value set for the output.

## 6.6 Control Input S1

A signal between S1 and 0 V has the effect that

- all channels previously de-activated due to overloading can now be re-activated.
- specific channels can be activated or de-activated.

### 6.6.1 Re-activating Tripped Channels

Apply a signal for at least 0.5 seconds. All channels previously de-activated due to overloading are then re-activated in sequential order, based on the load applied.

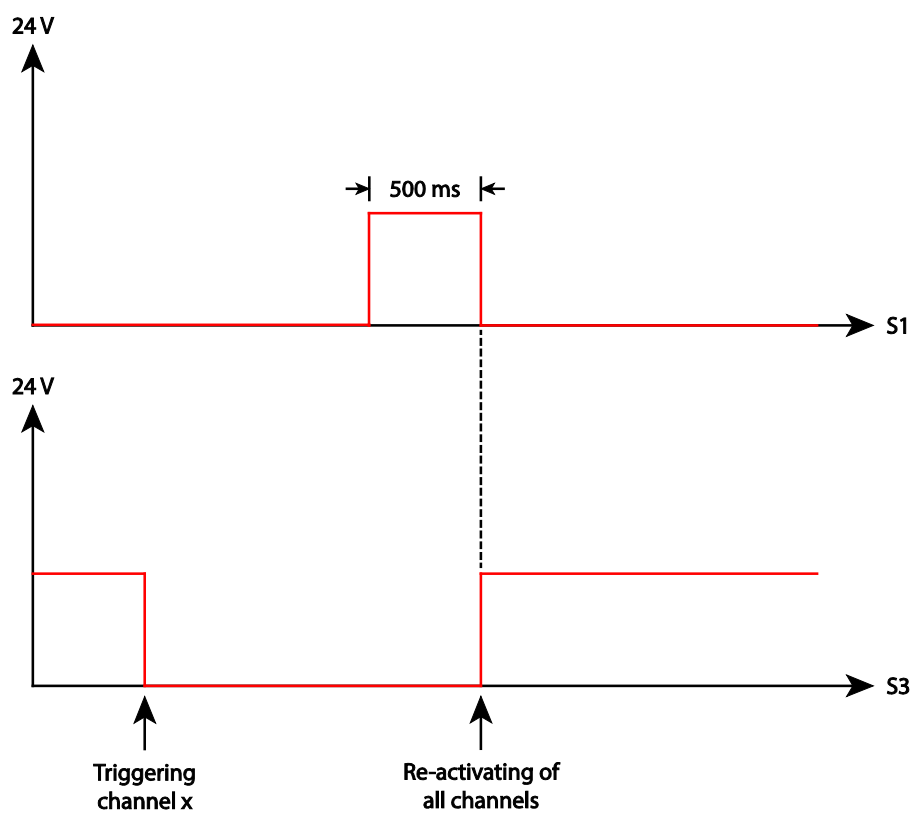

Figure 18: Example of re-activation via control input S1, or signal output S3.

## 6.6.2 Specific Activation and De-activation of Non-Tripped Output Channels

A coded pulse pattern must be present to activate and de-activate specific output channels. The encoded pulse pattern can consist of

- 17 bits or
- 89 bits (with Firmware 2.0 and higher),

which must be transmitted as "Manchester code" (based on IEEE 802.3). Here, a falling clock pulse denotes a logical zero ("0"), and a rising clock pulse a logical one ("1").

The first bit to be transmitted has the value "0" and serves as the start bit, after which either 16-bit or 88-bit user data is transmitted.

No separate pulse signal is applied; the electronic circuit breaker obtains the pulse signal from the pulse pattern that is received. The circuit breaker is then synchronized automatically and transmits the current status back via signal output S2.

### Note



#### Observe the Number of the Output Channels!

The following tables and figures have been granted to:

- 787-1662: output channels 1 ... 2 are valid
- 787-1664: output channels 1 ... 4 are valid
- 787-1668: output channels 1 ... 8 are valid

Invalid bits and bytes will not be analyzed. They will be transmitted in an undefined state.

The table below provides an overview of the functions for the individual data bits:

Table 20: Bit Allocation for Control Input S1

Bit	Output channel	Byte	Function
1			START bit, value = "0"
2	Channel 8	Byte 1	Required switching statuses of output channels "1" = The corresponding output channel is activated. "0" = The corresponding output channel is deactivated.
3	Channel 7		
4	Channel 6		
5	Channel 5		
6	Channel 4		
7	Channel 3		
8	Channel 2		
9	Channel 1		

10	Command bit "switching status"	Byte 2	"1" = The required switching statuses of the output channels (Byte 1) are accepted. "0" = The required switching statuses of the output channels (Byte 1) are ignored.
11	Command bit "protocol length"		"1" = The extended 89-bit protocol is being used; the circuit breaker is transferring additional user data.* "0" = The short 17-bit protocol is being used.
12	Command bit "current value"		"1" = The momentary input voltage and the nominal currents set at the current selection switch are being transferred.* "0" = The momentary input voltage and the momentary output currents are being transferred.**
13			Pulse signal for signal output S2, value = "0"
14			
15			
16			
17			
18 ... 25		Byte 3	Pulse signal for signal output S2, value = "0"
26 ... 33	Channel 1	Byte 4	
34 ... 41	Channel 2	Byte 5	
42 ... 49	Channel 3	Byte 6	
50 ... 57	Channel 4	Byte 7	
58 ... 65	Channel 5	Byte 8	
66 ... 73	Channel 6	Byte 9	
74 ... 81	Channel 7	Byte 10	
82 ... 89	Channel 8	Byte 11	
18 or 90			STOP bit (1.5 pulse cycles) For 17-bit protocol: Bit 18 For 89-bit protocol: Bit 90

\* This function is supported starting with Firmware 2.10 for the 787-1664 and 787-1664/0106-0000 and with Firmware 2.00 for the 787-1664/0006-1000.

\*\* This function is supported starting with Firmware 2.10 for the 787-1664/0006-1000.

Depending on the valence of bit 12 (byte 2), either the set nominal currents or the momentary output currents are transferred in addition to the momentary input voltage (see Table 22).

Electronic circuit breakers without active current limitation supply only the momentary input voltage and the set nominal currents. Output currents are not transferred.

Changing of the signal voltage from 15 V ... 30 VDC to 0 V ... 5 VDC (falling clock pulse) corresponds to a logical zero ("0").

Changing of the signal voltage from 0 V ... 5 VDC to 15 V ... 30 VDC (rising clock pulse) corresponds to a logical one ("1").

The minimum pulse period is 70 ms, the maximum 200 ms.

A jitter of ±5 % or ±5 ms is acceptable, with the higher value applying.

STOP Bit: The STOP bit uses 1.5 pulse cycles. During this time, the PLC may not transmit any further bit.

Once the pulse pattern has been transmitted, S1 and S2 are returned to Low. A new pulse pattern cannot be transmitted until after a period of 200 ms.

The coded pulse pattern must be generated in the PLC via an XOR link from an auxiliary clock pulse and the data bits. This is illustrated by the examples in the figures below:

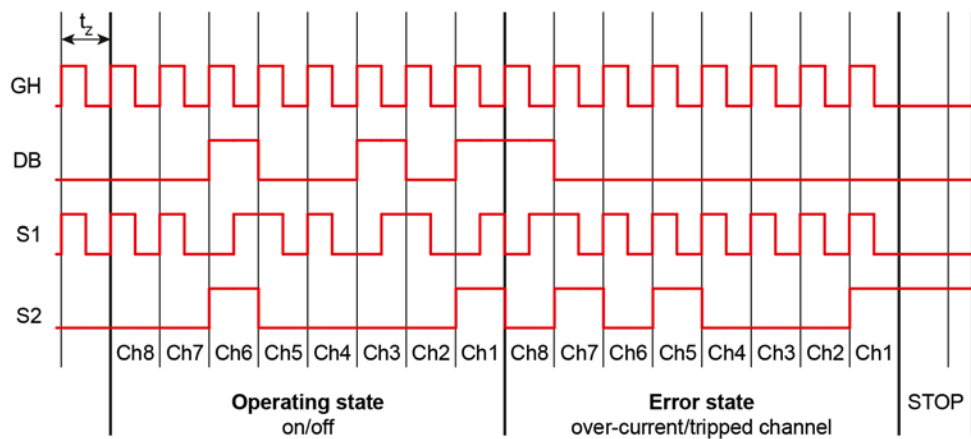

Figure 19: Standard 17-bit protocol

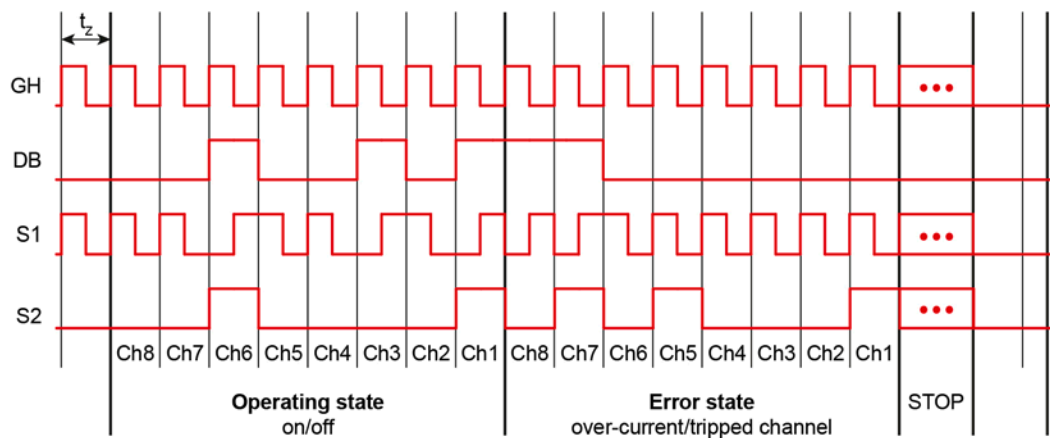

Figure 20: Extended 89-bit protocol



Table 21: Key for the "Standard 17-bit protocol" and "Extended 89-bit protocol" figures

<b>Description</b>	<b>Description</b>
t <sub>z</sub>	Cycle duration: 70 ms ... 200 ms
GH	Generated auxiliary clock pulse in the PLC
DB	Data bits from PLC to device
S3	PLC output (control input S1 of the circuit breaker) created from an XOR link between data bits and an auxiliary clock pulse
S2	PLC input SPS (signal output S2 of the circuit breaker) Data bits valid at the falling clock pulse
Ch1 ... Ch8	Output channel 1 ... Output channel 8

## *Information*



### **Function Blocks for PLC**

Upon request, WAGO can provide a library with CoDeSys function blocks for your PLC. Simply contact our Support unit.

## 6.7 Signal Output S2

The status of the 4 output channels can be queried at signal output S2. This output channel is short-circuit proof and has a common potential with the power supply ground.

---

### Note



#### Use signal output S2 with a PLC!

Connect the supply ground of the electronic circuit breaker with the ground of the PLC when you use signal output S2 with a PLC!

---

When a coded sampled signal is transmitted via control input S1, the circuit breaker is synchronized automatically. The current status of the output channels is then transmitted via signal output S2.

---

### Note



#### Observe the Number of the Output Channels!

The following tables and figures have been granted to:

- 787-1662: output channels 1 ... 2 are valid
- 787-1664: output channels 1 ... 4 are valid
- 787-1668: output channels 1 ... 8 are valid

Invalid bits and bytes will not be analyzed. They will be transmitted in an undefined state.

---

The table below provides an overview of the 17 data bits at signal output S2. A distinction is drawn here between the status "on/off" and the error status "tripped/overcurrent".

Table 22: Bit allocation for signal output S2

Bit	Output channel	Byte	Function
1			START bit, value = "0"
2	Channel 8	Byte 1	<b>Switching status</b> "1" = The corresponding output channel is activated. "0" = The corresponding output channel is deactivated.  <b>Error status</b> "1" = The corresponding output channel is still activated, but with over-current (output current < nominal current, longer than 1 s). "0" = The corresponding output channel has been deactivated due to over-current.
3	Channel 7		
4	Channel 6		
5	Channel 5		
6	Channel 4		
7	Channel 3		
8	Channel 2		
9	Channel 1		
10	Channel 8	Byte 2	"1" = Error status indicated in Byte 1. "0" = Switching status indicated in Byte 1
11	Channel 7		
12	Channel 6		
13	Channel 5		
14	Channel 4		
15	Channel 3		
16	Channel 2		
17	Channel 1		
18 ... 25		Byte 3	Current input voltage ((value transmitted)/16) + 16 V
26 ... 33	Channel 1	Byte 4	Current *) Output channel 1
34 ... 41	Channel 2	Byte 5	Current *) Output channel 2
42 ... 49	Channel 3	Byte 6	Current *) Output channel 3
50 ... 57	Channel 4	Byte 7	Current *) Output channel 4
58 ... 65	Channel 5	Byte 8	Current *) Output channel 5
66 ... 73	Channel 6	Byte 9	Current *) Output channel 6
74 ... 81	Channel 7	Byte 10	Current *) Output channel 7
82 ... 89	Channel 8	Byte 11	Current *) Output channel 8
18 or 90			STOP bit (1.5 pulse cycles) For 17-bit protocol: Bit 18 For 89-bit protocol: Bit 90

\*) (value transmitted)/16 A

Depending on the valence of bit 12 (byte 2), either the set nominal currents or the momentary output currents are transferred in addition to the momentary input voltage (see Table 20).

Electronic circuit breakers without active current limitation supply only the momentary input voltage and the set nominal currents. Output currents are not transferred.

## 6.8 Functioning of Communication between Control Input S1 and Signal Output S2

The 787-1664 electronic circuit breaker can be remotely controlled via control input S1 when it is linked to a higher-order control system. The operating statuses can also be read out at the same time via signal output S2.

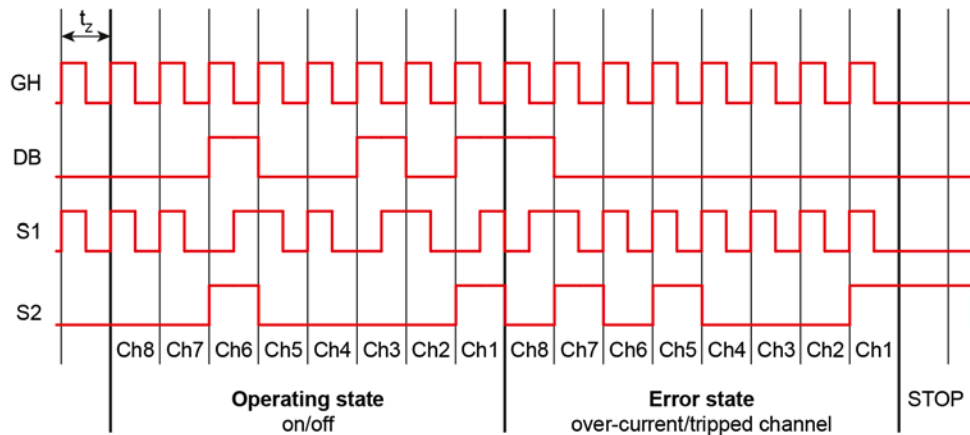

Figure 21: Example of a pulse pattern at control input S1 and signal output S2.

1. The PLC transmits a coded pulse pattern to control input S1. The coding is given in the table "Bit allocation for control input S1". In this case, Bit 10 determines whether output channels are to actually be activated or deactivated.
2. The circuit breaker synchronizes itself automatically. The current status of all output channels is transmitted back simultaneously via signal output S2. The transmitted data is not sent as Manchester code, but as binary encoded.
3. The PLC should be programmed such that it applies the current status each time shortly after any edge slope change to avoid any erroneous signaling or delays.
4. If there is an overload (over-current) at an output, the circuit breaker will generate a cyclic pulse at signal output S2. This pulse consists of a 500ms high signal that is transmitted every three seconds. This pulse continues to be transmitted until the PLC queries the current status.

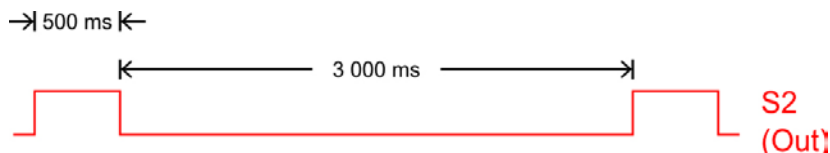

Figure 22: Cyclic over-current pulse.

## 6.9 Signal Output S3

A group signal can be queried at signal output S3 to determine the status of the 4 channels. In contrast to signal output S2, output S3 delivers a 24 VDC voltage if no channel has been tripped. This voltage drops to 0 V as soon as at least one channel has been tripped.

This output is short-circuit proof and can withstand a maximum load of 20 mA. It also has a common potential with the power supply ground.

---

### **NOTICE**

#### **Protect the signal output against voltage peaks!**

Voltage peaks can occur at signal output S3 when a relay connected to the unit is de-activated. This can damage or destroy the signal output. We recommend installing a recovery diode in parallel to the relay to prevent this.

---

## List of Figures

Figure 1: View of device .....	14
Figure 2: 24 V input .....	15
Figure 3: 0 V input .....	15
Figure 4: Fuse-protected outputs Ch1 ... Ch4.....	16
Figure 5: Control and signaling contacts.....	16
Figure 6: Indicators .....	17
Figure 7: Buttons .....	18
Figure 8: Rotary Switch .....	19
Figure 9: Mounting the device on the DIN 35 rail .....	26
Figure 10: Mounting the device on the DIN 35 rail .....	26
Figure 11: Removing the device from the DIN 35 rail .....	27
Figure 12: Removing the device from the DIN 35 rail .....	27
Figure 13: Connection example .....	28
Figure 14: Trip Curve for the 10 A Circuit Breaker 787-1664 .....	29
Figure 15: Trip Curve for the 6 A Circuit Breaker 787-1664/0106-0000.....	30
Figure 16: Trip Curve for the 6 A Circuit Breaker with Active Current Limitation 787-1664/0006-1000.....	30
Abbildung 17: Operating Statuses, Signaling, Reactions.....	35
Figure 18: Example of re-activation via control input S1, or signal output S3.....	37
Figure 19: Standard 17-bit protocol .....	40
Figure 20: Extended 89-bit protocol .....	40
Figure 21: Example of a pulse pattern at control input S1 and signal output S2..	44
Figure 22: Cyclic over-current pulse.....	44

## List of Tables

Table 1: Versions.....	5
Table 2: Number notation.....	8
Table 3: Font conventions .....	8
Table 4: Fuse Protection of Output Channels .....	13
Table 5: Key for "Device view" figure.....	14
Table 6: Power supply connections.....	15
Table 7: Power supply connections.....	15
Table 8: Connections – Fuse-protected outputs .....	16
Table 9: Connections – Control and signaling contacts .....	16
Table 10: Legend for "Indicators" figure .....	17
Table 11: Rotary Switch Settings.....	19
Table 12: Device data.....	20
Table 13: Technical data - "Input" .....	21
Table 14: Technical data - "Output".....	22
Table 15: Technical data - "Ambient conditions" .....	23
Table 16: Technical data - "Signaling" .....	23
Table 17: Standard reference values for 787-1664 and 787-1664/0106-0000.....	33
Table 18: Standard reference values for 787-1664/0006-1000.....	33
Table 19: Operating statuses, signaling, reactions .....	34
Table 20: Bit Allocation for Control Input S1 .....	38
Table 21: Key for the "Standard 17-bit protocol" and "Extended 89-bit protocol" figures .....	41
Table 22: Bit allocation for signal output S2 .....	43

WAGO Kontakttechnik GmbH & Co. KG  
Postfach 2880 • D-32385 Minden  
Hansastraße 27 • D-32423 Minden  
Phone: +49/5 71/8 87 – 0  
Fax: +49/5 71/8 87 – 1 69  
E-Mail: info@wago.com  
Internet: <http://www.wago.com>

